



**Lighting The Future**

**2018-2019**

 **NightSearcher**

For 29 years now NightSearcher has been pushing the boundaries of lighting technology in the quest to design and manufacture the best portable rechargeable LED lighting systems on the market. Our main objective is simple: we want to offer products of unsurpassed quality and renown reliability that utilise the constantly evolving technologies to their fullest potential.

Our diverse range of products is continuously being developed to meet the requirements of our professional customers, including the police, fire & rescue, armed forces, railways, sports clubs, and utility companies, both in the UK and around the world.

We manufacture the most powerful rechargeable LED floodlights and searchlights in the world.

*Cotin Howard* Managing Director



SOCOTEC registered certification to ISO 9001:2015.



All new products are designed to minimise our impact on the environment.



NightSearcher began manufacturing lighting systems in 1989 and have continued producing these from our UK head office in Portsmouth, UK

## NightSearcher New Products for 2018-2019



**Solaris Range 20K**  
Page 4-11



**Tower Star - Floodlight**  
Page 19



**Gripper Lights**  
Page 27



**Panther XHP-X**  
Page 38



**Zoom Flash lights**  
Page 46



**Magnum 11,600**  
Page 52



**Zoom580R**  
Page 60-61



**Micro 1000 Work light**  
Page 92

## The Solaris Range, Portable Floodlights

Solaris Lite 20K	P4-5
Solaris Duo Li-ion 40K	P6-7
Solaris MegaStar Lite 20K	P8-9
Solaris Megastar 20K	P10
Solaris Maxi 20K	P11

## Rechargeable Work Lights

Galaxy Pro	P12-13
Galaxy Mini-1000	P14
Galaxy 1000 or 2000	P15
Galaxy 1500R	P16-17
Galaxy-Dual	P18

## AC Mains Work Lights, Floodlights and High Bay Lights

Tower Pro Flood Light	P19
Galaxy 6000 Work Light	P20-21
EcoStar Pro/Linkable Flood Light	P22-23
WorkBrite Work Lights	P24-25
Festoon Lights	P26
Gripper Inspection Lamp	P27
Fast Star Security Lights	P28-29
Wobblelight® JR. Site Light	P30
Beat-Lite Work Light	P31
Hi-Star High Bay Light	P32-33

## Searchlights

ProStar	P34-37
Panther XHP-X	P38
Puma XML	P39
Trio-550	P40-41
SoloStar	P42
Trigger Pro	P43
SL360	P44
SL1600	P45

## Flashlights

Zoom Spot to Flood	P46-48
Explorer-1000	P49
Magnum-1100	P50
Magnum-3500	P51
Magnum-11600	P52
Explorer XML-X	P53
Navigators	P54-55
KeyStar	P56-57
Explorer Pen Light	P58
USB Rechargeable Lithium Battery	P59

## Head Torches

Zoom 580R	P60-61
Light Wave	P62
HT800RX	P63
Hi-Vis Vest With Light	P64
Beanie Head Torch	P65

## Atex Range

EX-1400R Floodlight	P67
Atex Linear Lights	P68
EX-17000 Floodlight	P69
SOLAREX-4800 Floodlight	P70
EX-160R Flashlight	P71
EX-ZOOM160 Flashlight	P72
EX-PL67 Pen Light	P73
EX-150 Flashlight	P73
EX-325 Right Angle Hand Torch	P74
EX-185 Flashlight	P75
Helmet Clips	P76
EX-HT220, EXT180 Head Torches	P77

## Solar Lights

Solar Sentry-400	P78-9
Solar Sentry-1000	P80
Solar Sentry-1100RC	P81

## Pulsar - Hazard Warning Lights

Pulsar Pro Rechargeable	P82-83
Sequential Rechargeable Pulsar Pro	P84
Single Pulsar-AAA	P85

## Automotive

Pro-250 Inspection Light	P86-87
i-Spector 220 Inspection Light	P88
Star Blade Inspection Light	P89
i-Spector 700 Inspection Lamp	P90
i-Spector 1000 Inspection Light	P91
Micro-1000 Work Light	P92
Star Buddy Work Light	P93
PocketStar Inspection Light	P94
LifeGuard Emergency Car Kit	P95
StarBooster Jump Starter	P96
StarBooster-X Jump Starter	P97
RiteStar 400 - CRI Pen Light	P98
RiteStar 400 - CRI Inspection Light	P99
RiteStar 700 - CRI Work Light	P100

## UV Flashlights and Inspection light

UV395	P101
UV365	P102
I-Spector UV	P103

## Elite Sports and Camping Lights

DarkStar Head Torch	P104
Run Smart Head Torch	P105
EnduraStar Sports Light	P106
Dual Star Camping torch	P107

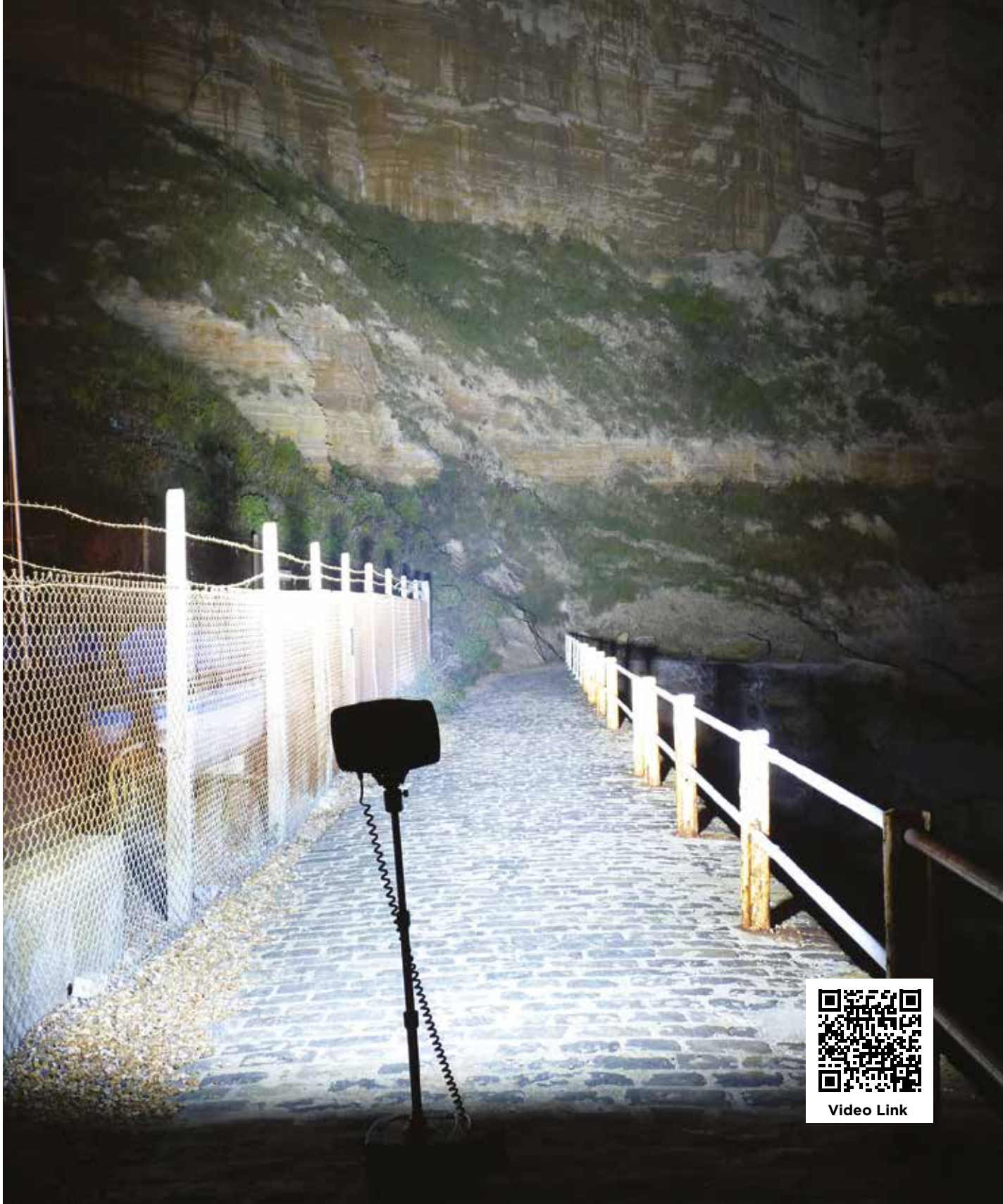

**Shoulder strap for easy transportation**



**Storage compartment**



**Battery status Indicator**

# Solaris Lite 20K

## Portable Lightweight Rechargeable LED Floodlight

The new improved 20,000 lumen Solaris Lite range uses the latest in LED technology, providing very powerful portable unit. This unit can be set up in less than 1 minute for rapid deployment in emergency situations, and is made from very tough ABS plastic to ensure long operating life and reliability for all situations.



**UPGRADED  
VERSION  
20,000  
LUMENS**

**3  
YEAR  
WARRANTY\***



### KEY FEATURES:

- 20,000 Lumens
- 50 metre beam
- Runs up to 32 hours
- 3 Choices of batteries
- Battery status indicator
- Storage compartment
- Shoulder strap for easy transportation
- Compact design
- Set up in seconds
- Swivel and tilting head
- Lightweight and weatherproof
- Tough ABS plastic construction
- 1.7 metre extension pole

### 3 Battery sizes available:

#### 18Ah Lithium Battery

LIGHT OUTPUT	<b>20,000</b> LUMENS	10,000 LUMENS	4,000 LUMENS	2000 LUMENS
Beam	50 METRES	37.5 METRES	25 METRES	12.5 METRES
RUN TIMES	2hrs	4hrs	8hrs	16hrs
RECHARGEABLE LITHIUM BATTERY	IP65 RATING	CHARGING TIME 7HRS	8 KG	

PRODUCT CODE: NSSOLARISLITE20K-LI-ION-18  
CAT/PAD: 0111/108165

#### 36Ah Lithium Battery

LIGHT OUTPUT	<b>20,000</b> LUMENS	10,000 LUMENS	4,000 LUMENS	2,000 LUMENS
Beam	50 METRES	37.5 METRES	25 METRES	12.5 METRES
RUN TIMES	4hrs	8hrs	16hrs	32hrs
RECHARGEABLE LITHIUM BATTERY	IP65 RATING	CHARGING TIME 10HRS	9.3 KG	

PRODUCT CODE: NSSOLARISLITE20K-LI-ION-36

#### 22Ah SLA Battery

LIGHT OUTPUT	<b>20,000</b> LUMENS	10,000 LUMENS	4,000 LUMENS	2,000 LUMENS
Beam	50 METRES	37.5 METRES	25 METRES	12.5 METRES
RUN TIMES	2hrs	4hrs	8hrs	16hrs
RECHARGEABLE SLA BATTERY	IP65 RATING	CHARGING TIME 8HRS	12.8 KG	

PRODUCT CODE: NSSOLARISLITE20K-SLA-22

### Optional accessories:



Stability legs  
increase height and  
stability to 1.7m:  
SPSOLARISLEGMK2



Diffused  
colour filters



5-Way Multi Charger  
For SLA Batteries  
CH5WAY



5 Way Multi Charger  
Li-ion 16.8V  
CH5WAYLI-ION

DIMENSIONS: Head Size - 248x300x58mm  
Case Size - 140x250x180mm  
Boxed Size - 460x460x320mm



Video Link



Quick lock/ release



Stability feet



Battery status indicator  
Green | Amber | Red

# Solaris Duo Li-ion 40K

## 40,000 Lumens Rechargeable Lighting System

The new improved 40,000 Solaris Duo is truly the best replacement for generator powered halogen lights as they are fully portable, emit no noise or emissions and run cool making them safe for confined spaces. All units can be fully assembled in seconds.



**UPGRADED  
VERSION  
40,000  
LUMENS**

**LIFETIME  
CASE  
WARRANTY**

### KEY FEATURES:

- 40,000 lumens
- 50 metre beam
- Runs up to 24 hours
- Rechargeable lithium battery
- 2 Choices of batteries
- Stability feet
- Battery status indicator
- Housed in an unbreakable IP67 polycarbonate case
- Swivel and tilting head
- Sturdy, stackable and weatherproof
- 2 x 1.9 metre extension poles

### 2 Battery sizes available:

#### 36Ah Lithium Battery

	<b>40,000 LUMENS</b>	<b>20,000 LUMENS</b>	<b>8,000 LUMENS</b>	<b>4,000 LUMENS</b>
	<b>50 METRES</b>	<b>37.5 METRES</b>	<b>25 METRES</b>	<b>12.5 METRES</b>
	<b>2hrs</b>	<b>4hrs</b>	<b>8hrs</b>	<b>16hrs</b>
RECHARGEABLE LITHIUM BATTERY	IP67 RATING	CHARGING TIME 10HRS	DIMENSIONS 280mm x 380mm x 570mm	20.7 KG

PRODUCT CODE: NSSOLARISDUO20K-LI-ION-36

#### 50Ah Lithium Battery

	<b>40,000 LUMENS</b>	<b>20,000 LUMENS</b>	<b>8,000 LUMENS</b>	<b>4,000 LUMENS</b>
	<b>50 METRES</b>	<b>37.5 METRES</b>	<b>25 METRES</b>	<b>12.5 METRES</b>
	<b>3hrs</b>	<b>6hrs</b>	<b>12hrs</b>	<b>24hrs</b>
RECHARGEABLE LITHIUM BATTERY	IP67 RATING	CHARGING TIME 12HRS	DIMENSIONS 280mm x 380mm x 570mm	21 KG

PRODUCT CODE: NSSOLARISDUO20K-LI-ION-50  
CAT/PAD: 0111/112259

### Optional accessories:



5 Way Multi Charger  
Li-ion 16.8V  
CH5WAYLI-ION  
CAT/PAD: 0111/114510



Diffused  
colour filters



Everything stores  
inside case



Extendable handle and wheels.  
Available in orange or black



Photo taken by Monifieth Athletic FC



Photo taken by ontheedgetennis



Photo taken by ontheedgetennis



# Solaris MegaStar Lite 20K

## Portable Rechargeable Sports Lighting

The new improved 20,000 rechargeable floodlight which is quick and easy to assemble. The Solaris MegaStar range is perfect to use on a wide range of sport events and coaching grounds. When used on full power 8 units will illuminate a 60 x 40 metre area for 2 - 16 hours training, allowing players to train into the darkness.

**UPGRADED  
VERSION  
20,000  
LUMENS**

**3  
YEAR  
WARRANTY\***



### KEY FEATURES:

- 20,000 lumens
- 50 metre beam
- Lightweight rechargeable battery pack - easier to carry and store, runs up to 16 hours
- Fully rechargeable means no expensive, noisy generator required
- No planning permission required
- Quick and easy to assemble
- Glare free operation
- Perfect for outdoor use in all weather
- Adjustable 3 section pole with safety locking pins
- Easy to transport and store
- Utilise previously unplayable pitches
- Lightweight aluminium tripod which extends to 3.5 metres

### 18Ah Lithium Battery

LIGHT OUTPUT	<b>20,000 LUMENS</b>	<b>10,000 LUMENS</b>	<b>4,000 LUMENS</b>	<b>2,000 LUMENS</b>
Beam	<b>50 METRES</b>	<b>37.5 METRES</b>	<b>25 METRES</b>	<b>12.5 METRES</b>
RUN TIMES	<b>2hrs</b>	<b>4hrs</b>	<b>8hrs</b>	<b>16hrs</b>
RECHARGEABLE LITHIUM BATTERY	IP44 RATING	CHARGING TIME 8HRS	DIMENSIONS 330mm x350mm x310mm	10.5 KG

PRODUCT CODE: NSSOLARISMEGA20K-LI-ION-18

**Ideal for training and coaching grounds.  
8 Units light half a pitch 60x40 metre area**

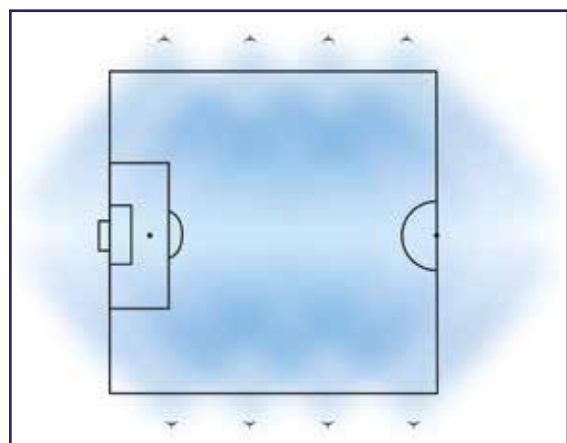

Low level cable.  
Control switch for  
light settings

### Optional accessories:



5 Way Multi Charger  
Li-ion 16.8V  
CH5WAYLI-ION



3 x Stability  
ground pegs  
SPTRIPODPEGS

# Solaris Megastar 20K

## Rechargeable Floodlights For The Emergency Services

The new improved 20,000 Solaris Megastar and Maxi floodlights are quick and easy to setup and can illuminate the crime scene for up to 28 hours. These robust weatherproof lights are used by the police, fire and rescue teams and utility groups and are ideal for illuminating an area up to 50 metres.

### KEY FEATURES:

- 20,000 lumens
- 50 metre beam
- Rechargeable battery pack which runs up to 28 hours means no expensive, noisy generator required
- No planning permission required
- Quick and easy to assemble
- Virtually unbreakable polyethylene casing with polycarbonate lens
- Glare free operation
- Battery status indicator
- Robust weatherproof construction
- Easy to transport and store
- Lightweight aluminium tripod which extends to 3.5 metres

### 2 Battery sizes available:

#### 24Ah SLA Battery

LIGHT OUTPUT	<b>20,000</b> LUMENS	<b>10,000</b> LUMENS	<b>4,000</b> LUMENS	<b>2,000</b> LUMENS
Beam	<b>50</b> METRES	<b>37.5</b> METRES	<b>25</b> METRES	<b>12.5</b> METRES
RUN TIMES	<b>2hrs 15MIN</b>	<b>4hrs 30MIN</b>	<b>9hrs</b>	<b>18hrs</b>
RECHARGEABLE SLA BATTERY	IP44 RATING	CHARGING TIME 7HRS	DIMENSIONS 225mm x200mm 100mm	14.6 KG

PRODUCT CODE: NSSOLARISMEGA20K-SLA-24

#### 38A SLA Battery

LIGHT OUTPUT	<b>20,000</b> LUMENS	<b>10,000</b> LUMENS	<b>4,000</b> LUMENS	<b>2,000</b> LUMENS
Beam	<b>50</b> METRES	<b>37.5</b> METRES	<b>25</b> METRES	<b>12.5</b> METRES
RUN TIMES	<b>2hrs 30MIN</b>	<b>7hrs</b>	<b>14hrs</b>	<b>28hrs</b>
RECHARGEABLE SLA BATTERY	IP44 RATING	CHARGING TIME 10HRS	DIMENSIONS 225mm x200mm 100mm	19.8 KG

PRODUCT CODE: NSSOLARISMEGA20K-SLA-38

**UPGRADED VERSION 20,000 LUMENS**

**3 YEAR WARRANTY\***

3.5m tripod

### Optional accessories:



5 Way Multi Charger  
Li-ion 16.8V  
CH5WAYLI-ION



3 x Stability ground pegs  
SPTRIPODPEGS



# Solaris Maxi 20K

## Rechargeable Floodlights For The Emergency Services



**UPGRADED  
VERSION  
20,000  
LUMENS**

**3  
YEAR  
WARRANTY\***

### KEY FEATURES:

- 20,000 lumens
- 50 metre beam
- Rechargeable battery pack which runs up to 28 hours means no expensive, noisy generator required
- Compact design, folds down to 40cm
- Quick and easy to assemble
- Virtually unbreakable polyethylene casing with polycarbonate lens
- Coiled lead to avoid trip hazards
- Adjustable 4 section pole with safety pins
- Battery status indicator
- Robust weatherproof construction
- Easy to transport and store
- Lightweight aluminium tripod which extends to 1.5 metres

### 2 Battery sizes available:

#### 24Ah SLA Battery

LIGHT OUTPUT	<b>20,000 LUMENS</b>	<b>10,000 LUMENS</b>	<b>4,000 LUMENS</b>	<b>2,000 LUMENS</b>
Beam	<b>50 METRES</b>	<b>37.5 METRES</b>	<b>25 METRES</b>	<b>12.5 METRES</b>
RUN TIMES	<b>2hrs 15MIN</b>	<b>4hrs 30MIN</b>	<b>9hrs</b>	<b>18hrs</b>
RECHARGEABLE SLA BATTERY	IP44 RATING	CHARGING TIME 7HRS	DIMENSIONS 225mm x200mm x150mm	14.6 KG

PRODUCT CODE: NSSOLARISMAXI20K-SLA-24

#### 38A SLA Battery

LIGHT OUTPUT	<b>20,000 LUMENS</b>	<b>10,000 LUMENS</b>	<b>4,000 LUMENS</b>	<b>2,000 LUMENS</b>
Beam	<b>50 METRES</b>	<b>37.5 METRES</b>	<b>25 METRES</b>	<b>12.5 METRES</b>
RUN TIMES	<b>3hrs 30MIN</b>	<b>7hrs</b>	<b>14hrs</b>	<b>28hrs</b>
RECHARGEABLE SLA BATTERY	IP44 RATING	CHARGING TIME 10HRS	DIMENSIONS 225mm x200mm x150mm	19.8 KG

PRODUCT CODE: NSSOLARISMAXI20K-SLA-38



### Optional accessories:



**5 Way Multi Charger  
Li-ion 16.8V  
CH5WAYLI-ION**



Video Link



Powerful wide angle,  
SMD LEDs



Built in storage compartment  
to conveniently store charger.



Change the angle to  
suit your need

## Powerful Robust Rechargeable LED Work Light

The Galaxy Pro is designed using the toughest composite materials for use in industrial applications where it is essential to have robust products. Utilising the very latest LED technology the Galaxy Pro produces a very impressive 3500 Lumens output and gives a wide floodlight beam in of 30m.



**3**  
YEAR  
WARRANTY\*

Hi-Vis reflective strips on the feet

### KEY FEATURES:

- 3,500 Lumens
- 30 metre beam
- Runs up to 24 hours
- Rechargeable lithium battery - 7.4V 13.2Ah
- Very robust housing
- Impact resistant to 1 metre
- Lightweight and weatherproof
- Dimmable
- Battery charging indicator + low battery warning

	HIGH	LOW	DIMMABLE	
LIGHT OUTPUT	<b>3500</b> LUMENS	<b>1750</b> LUMENS	<b>3500</b> -100 LUMENS	
Beam	<b>30</b> METRES	<b>15</b> METRES	<b>0-30</b> METRES	
RUN TIMES	<b>4hrs</b>	<b>8hrs</b>	<b>24hrs</b>	
RECHARGEABLE LITHIUM BATTERY	IP54 RATING	CHARGING TIME 10HRS	DIMENSIONS 310mm x350mm X285mm	1.52 KG

PRODUCT CODE: NSGALAXYPRO  
CAT/PAD: 0111/111966



Optional Single or double tripods available

SPTRIP0D1.7  
CAT/PAD: 0111/107803



Optional magnetic feet  
SPGALAXYPROMAG



## Galaxy E-Pro

The Galaxy E-Pro is the same as the Galaxy Pro except it has a smaller 7.4V 6.6Ah battery and shorter run time.

PRODUCT CODE: NSGALAXYE-PRO

	HIGH	LOW	DIMMABLE	
LIGHT OUTPUT	<b>3500</b> LUMENS	<b>1750</b> LUMENS	<b>3500</b> -100 LUMENS	
RUN TIMES	<b>2.5hrs</b>	<b>4.5hrs</b>	<b>12hrs</b>	1.24 KG

Supplied with: AC mains charger

### Optional accessories:

Vehicle Charger: CHIC8.4-LI-ION  
CAT/PAD: 0111/120648  
Magnetic built in feet: SPGALAXYPROMAG  
AC Mains Charger: CH-GALAXYPRO-UK

# Galaxy Mini-1000

## Rechargeable Pocket-sized LED Work Light

The pocket-sized Galaxy Mini-1000 is a powerful work light. It has robust edge protection and is impact resistant to 1 metre, so can withstand hard knocks in the workplace. The battery charging and status indicator button lets you know when it's time to recharge. The Galaxy Mini-1000 includes a built-in powerbank so you can charge your mobile phone whilst you work! A great little addition to any workshop.



### KEY FEATURES:

- 1,000 Lumens - 25 metre beam
- Runs up to 6.5 hours
- Compact size
- Impact resistant to 1 metre
- Rechargeable lithium battery - 3.7V 4400mAh
- Carry handle
- Battery charging + status indicator
- Supplied with: USB Charging cable

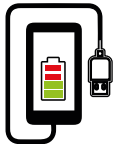

USB Power bank - charge your phone

	HIGH	LOW	SOS	FLASHING
<b>LIGHT OUTPUT</b>	1000 LUMENS	500 LUMENS	1000 LUMENS	1000 LUMENS
<b>Beam</b>	25 METRES	12.5 METRES	25 METRES	25 METRES
<b>Runtime</b>	3hrs	6.5hrs	3hrs	2.5hrs
<b>RECHARGEABLE LITHIUM BATTERY</b>	<b>IP44 RATING</b>	<b>CHARGING TIME 6HRS</b>	<b>DIMENSIONS 170mm x42mm x12.7mm</b>	<b>455g</b>

PRODUCT CODE: NSGALXYMINI1000



Optional tripod available SPTRIP0D1.7



180° Degree Foldable Bracket/Handle



Heavy Duty Edge protection

### Optional accessories:



EU Adaptor: CH-USB-EU



12/24V Vehicle Charger: CHIC3\_7-LI-ION



AC Adaptor: CH-USB-UK

# Galaxy 1000 or 2000

## Compact, Lightweight Rechargeable LED Work Light

The Galaxy 1000/2000 LED portable rechargeable work light is ideal for inspection and other tasks where a lightweight portable solution is required. It has a 360° movement thanks to the adjustable bracket and folds flat for easy storage. This powerful light is protected by the shatterproof polycarbonate lens and high impact ABS housing.

2 Models available:



### KEY FEATURES:

- 1,000 or 2,000 Lumens
- 10 or 20 metre beam
- Runs up to 4 hours
- Rechargeable lithium battery
- Fold flat design for compact storage
- Lightweight compact design
- Carry handle/Floor standing
- Battery charging indicator
- High impact ABS housing and shatterproof polycarbonate lens
- Overcharge and discharge protection



360° Degree handle and stand

## Galaxy 1000

Rechargeable lithium battery 7.4V 1800mAh

	HIGH	LOW		
	1000 LUMENS	500 LUMENS		
	10 METRES	5 METRES		
	1hrs 10MIN	3hrs 20MIN		
LITHIUM BATTERY	IP54 RATING	CHARGING TIME 4HRS	DIMENSIONS 193mm x230mm x63mm	539g

PRODUCT CODE: NSGALAXY1000

Supplied with: USB Charging cable

## Galaxy 2000

Rechargeable lithium battery 7.4V 4800mAh

	HIGH	LOW		
	2000 LUMENS	1000 LUMENS		
	20 METRES	10 METRES		
	2hrs	4hrs		
LITHIUM BATTERY	IP54 RATING WATERPROOF	CHARGING TIME 8HRS	DIMENSIONS 193mm x230mm x63mm	911g

PRODUCT CODE: NSGALAXY2000

Supplied with: 230V AC + Vehicle Charger



Optional tripod available SPTRIP0D1.7



Video Link

Optional accessories:



EU Adaptor: CH-USB-EU



12/24V Vehicle Charger: CHIC3\_7-LI-ION



AC Adaptor: CH-USB-UK





# NEW Galaxy 1500R

## Rechargeable Folding Work Lights - Folding case for Extreme Heavy Duty Protection

The Galaxy 1500R is a versatile lightweight portable work light, that has been designed for use on work sites where a power source is not readily available. The light has a robust housing to protect the lights when being transported or stored. The Galaxy 1500R easily folds out to a floor standing A-frame, giving multi-directional light.



Protective Folding Case Design



USB Power bank - charge your phone



### KEY FEATURES:

- 1,500 Lumens - 15 metre beam
- Runs up to 3 hours
- Rechargeable lithium battery - 7.4V 4400mAh
- Robust housing
- Anti-glare diffused lens for wide spread shadow free light
- Battery charging + status indicator
- Built in heat sink
- Supplied with: USB Charging cable

	HIGH	LOW		
	1500 LUMENS	750 LUMENS		
	15 METRES	7.5 METRES		
	1hrs 30MIN	3hrs		
	RECHARGEABLE LITHIUM BATTERY	IP54 RATING	CHARGING TIME 3.5HRS	DIMENSIONS 180mm x115mm x270mm
				1.22 KG

PRODUCT CODE: NSGALAXY1500R

### Three Light Modes:

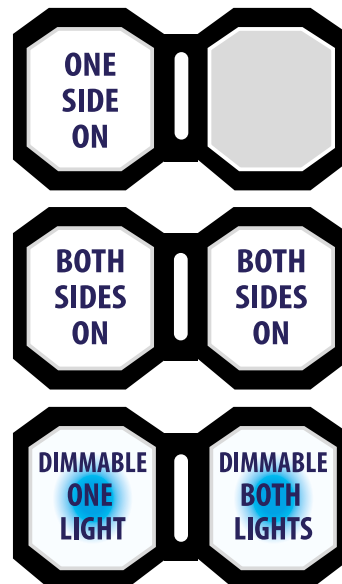

Optional tripod available SPTRIPOD1.7

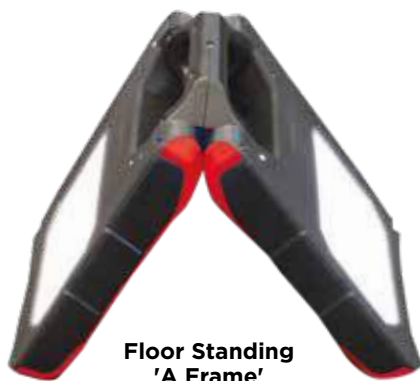

Floor Standing 'A Frame'

### Optional accessories:



EU Adaptor: CH-USB-EU



12/24V Vehicle Charger: CHIC3\_7-LI-ION



AC Adaptor: CH-USB-UK

# Galaxy-Dual

## Dual Powered AC Mains + Rechargeable Led Work Light

The Galaxy-Dual work light can be powered via AC mains or from its rechargeable Lithium battery. Making this product very versatile, where mains power is not always available.



### KEY FEATURES:

- 2,000 Lumens - 20 metre beam
- Runs up to 8 hours
- Rechargeable lithium battery - 3.7V 4400mAh
- Nylon stand and handle
- Rubberised moulded edge to prevent scratches
- Tough, die cast aluminium housing
- Impact Resistant to 1.5 metre
- Supplied with an AC adaptor and 5 metre cable

**DUAL  
POWER**



	HIGH	LOW	
LIGHT OUTPUT	2000 LUMENS	800 LUMENS	
Beam	20 METRES	10 METRES	
	2hrs	8hrs	1.3 KG
RECHARGEABLE LITHIUM BATTERY	110 OR 240V AC	IP65 RATING	CHARGING TIME 4HRS
			DIMENSIONS 220mm x225mm x70mm

PRODUCT CODE: NSGALXYDUAL

**AC MAINS  
110V OR 240V**

**RECHARGEABLE**



Optional tripod available  
SPTRIPOD3.5M



Optional accessories:



Galaxy Dual Tripod Mounting Plate:  
SPGALXY-DUALPLATE



Galaxy Dual Magnetic Mounting Bracket:  
SPGALXY-DUALMAG

# NEW TOWER PRO

## LED Flood light With Collapsible Tripod

The Tower Pro is a unique mains flood light, that has 360° degree room filling light. The foldable and lockable light heads have anti glare diffused lens giving wide spread shadow free light. The tripod with extends just over two metres and has a robust aluminium housing that will withstands knocks on building sites.



### KEY FEATURES:

- 16,000 Lumens
- 50 metre beam
- 360° fold out light
- Anti-glare diffused lens for wide spread
- Foldable and lockable light
- 6500K cool white colour temperature
- Robust housing absorbs knocks on site
- Extends up to 2.5 metres
- Supplied with heavy duty 10 metre cable:
  - HO7RN-F 3G 1.5mm x 6.7m
  - HO7RN-F 2G 1.0mm x 3.3m
  - 2.3 Metre tripod

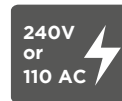

PRODUCT CODE: NSTOWERSTAR





**Two Light Modes:**

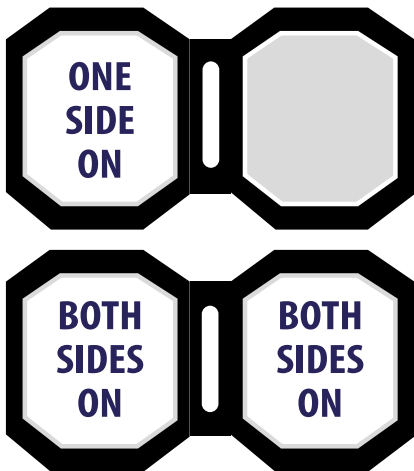

**Optional tripod  
available  
SPTRIPOD1.7**

# NEW Galaxy 6000

## AC LED Work Lights - Folding case for Extreme Heavy Duty Protection

The Galaxy 6000 work light range, allows you to connect with other lights and power tools. The light has a robust housing to protect the lights when being transported or stored. The Galaxy 6000 easily folds out to a floor standing A-frame, giving multi-directional light.



Protective Folding Case Design

### KEY FEATURES:

- 2 x 10W - 3,000 Lumens per light head
- Protective folding case design
- Anti-glare diffused lens for wide spread shadow free light
- Linkable lights
- Cool operation - no hot surfaces
- Carry handle - for easy transportation
- Ideal for painting/decorating
- Foldable and lockable light
- Built in heat sink
- Robust rubberised housing
- Supplied with heavy duty, 2 metre HO7RN-F cable

110V or 230V



Floor Standing 'A Frame'



# NEW Galaxy 6000-110

2 x 110V CEE sockets outlets -  
Connect tools or link lights together

	HIGH	LOW
LIGHT OUTPUT	<b>6000</b> LUMENS	<b>3000</b> LUMENS
Beam	<b>45</b> METRES	<b>24</b> METRES
IP54 RATING	LINKABLE LIGHTS	3.2 KG
DIMENSIONS 220mm x175mm x330mm		

PRODUCT CODE: NSGALAXYAC6000-110V



# NEW Galaxy 6000-230

2 x 230V BS sockets outlets -  
Connect tools or link lights together

PRODUCT CODE: NSGALAXYAC6000

# EcoStar Pro Linkable

## Industrial Linkable LED Floodlights

The ECOSTAR Pro 110V linkable is the lighting solution for the industrial, construction market and outdoor events. The extraordinary efficiency and performance over halogen means huge savings in running costs. Fitted with CEE 110V plug and socket allowing multiple lights to be linked together. Linkable versions enable convenient 'daisy chaining' and the LED energy efficiency allows very long cable runs.



### KEY FEATURES:

- High powered SMD LED
- Robust Aluminium casing
- Beam Angle: 120°
- Adjustable bracket
- IP65 Weather Proof Rating
- Can operate on power sources between 85V-265V AC 50-60Hz
- Low heat emission = with no cool down required before storage
- Light small or large area
- 0.5 Metre cable
- High performance heat sink

### 2 Models available:

	50W	100W
LIGHT OUTPUT	<b>4000 LUMENS</b> (50W)	<b>8000 LUMENS</b> (100W)
Beam	<b>8 METRES</b>	<b>10 METRES</b>
85-265V AC	<b>DIMENSIONS</b> 240mm x200mm x50mm	<b>DIMENSIONS</b> 300mm x245mm x60mm
IP65 RATING	<b>1.75 KG</b>	<b>3.10 KG</b>



Slim design

PRODUCT CODE: NSESPROLINK50  
CAT/PAD: 0111/107623  
NSESPROLINK100



# ECOSTAR PRO (Non Linkable)

## Industrial LED Floodlights

ECOSTAR Pro floodlights are powered by SMD LEDs offering double the illumination with lower energy consumption compared to halogen providing excellent performance and a notably shadow-free illumination.



### 2 Models available:

	50W	100W
LIGHT OUTPUT	<b>4000 LUMENS (50W)</b>	<b>8000 LUMENS (100W)</b>
Beam	<b>8 METRES</b>	<b>10 METRES</b>
85 -265V AC	<b>DIMENSIONS 240mm x200mm x50mm</b>	<b>DIMENSIONS 300mm x245mm x60mm</b>
IP65 RATING	<b>1.75 KG</b>	<b>3.10 KG</b>



Slim design

PRODUCT CODE: NSESPRO50  
CAT/PAD: 0111/107623

PRODUCT CODE: NSESPROLINK100

### Ecostar Pro Linkable Packages:

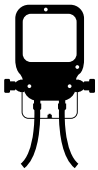

1 x linkable head  
**Choose a Tripod:**  
1.7m Swing Leg Tripod  
1.9m Tripod  
3.5m Tripod

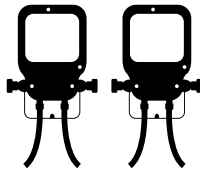

2 x linkable heads  
**Choose a Tripod:**  
1.7m Swing Leg Tripod  
1.9m Tripod  
3.5m Tripod  
**Choose a T-Bar:**  
1.9m Tripod T-bar  
3.5m Tripod T-bar

#### Add an extension lead:

14 Metre extension lead: (110v Only):



### Optional accessories:

#### Tripods:

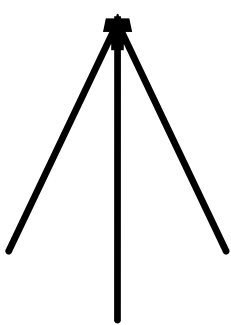

SWING LEGGED TRIPOD  
Max. (H) 1.7m  
SPTRIPODSL

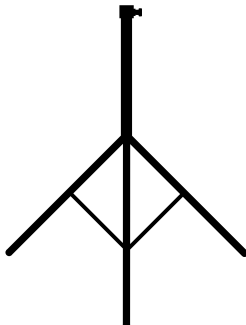

1.9M TRIPOD  
Max. (H) 1.9m  
SPTRIPOD1.9

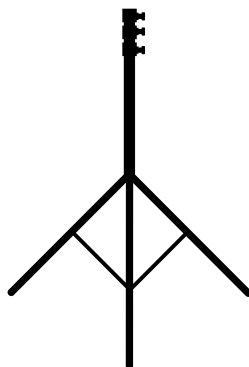

3.5M TRIPOD  
Max. (H) 3.5m  
SPTRIPOD3.5M

#### T-Bar:



The linkable is also available with a T-Bar bracket to fit the 1.9m or 3.5m  
**SPECOSTARTWINBRACKET**



14 Metre extension lead: (110v Only):  
**SPCABLE14M**

# WorkBrite Connect 2500 Or 4000

## AC Work Lights (Available with UK or EU connectors)

The WorkBrite Connect and Pro are highly durable work lights, built and designed to withstand use in industrial environments. Featuring 2 output sockets to connect power tools and to link lights together. The rubberised protective rim and aluminium body, that will withstands knocks on building sites.



### KEY FEATURES:

- 2,500 or 4000 Lumens
- 20 or 30 metre beam
- BS or EU sockets outlets - Connect tools or link lights together
- Impact resistant case and lens
- Carry handle - for easy transportation
- Die cast aluminium with rubberised protective rim
- Built-in kick back bracket
- 120° Beam angle
- Supplied with heavy duty, 1.8 metre HO7RN-F cable

### 2 Models available:

LIGHT OUTPUT	<b>2500 LUMENS</b>	<b>4000 LUMENS</b>
Beam	<b>20 METRES</b>	<b>30 METRES</b>
220V -240V AV	DIMENSIONS 320mm x258mm x83mm	DIMENSIONS 250mm x450mm x540mm
IP67 RATING	0.83 KG	1.09 KG
		LINKABLE LIGHTS

PRODUCT CODE: NSWORKBRITECON2500/EU  
PRODUCT CODE: NSWORKBRITECON4000/EU

# WorkBrite Pro

## AC Work Lights (Available with UK or EU connectors)

The WorkBrite Pro has a robust rubberised casing, built and designed to withstand the harshest industrial environments. Featuring 2 output sockets to connect power tools and to link lights together. With a carry handle and 4 level foldable bracket with fold flat design, ensures it is easy to transport.



### KEY FEATURES:

- 2,500 Lumens
- 20 metre beam
- 2 x BS/EU sockets outlets - Connect tools or link lights together
- Robust rubberised casing for maximum protection
- Carry handle - for easy transportation
- Die cast aluminium with rubberised protective rim
- Diffused lens
- Built-in heat sink
- 4 Level foldable bracket - fold flat design
- Supplied with heavy duty 1.8 metre HO5RN-F cable + plug clip

LIGHT OUTPUT	<b>2500 LUMENS</b>	
Beam	<b>20 METRES</b>	LINKABLE LIGHTS
220V -240V AV	IP54 RATING	DIMENSIONS 290mm x230mm x95mm
	2.25 KG	

PRODUCT CODE: NSWORKBRITEPRO/EU



# WorkBrite 800 to 4000

## AC Work Lights (Available with UK or EU connectors)





The WorkBrite work light are highly durable, built and designed to withstand use in industrial environments. The slim, fold-flat design and carry handle ensures it is easy to transport and store. The work light features a robust ABS plastic housing & tempered glass, making it ideal for day to day use on site.



### KEY FEATURES:

- 800 to 4000 Lumens
- 10 or 30 metre beam
- Slim fold flat design
- Robust ABS plastic housing, that withstands knocks on site
- Fold flat design
- Energy efficient - cool to touch
- Carry handle for easy transportation
- 1 metre impact resistant case
- Tempered glass
- Supplied with heavy duty, HO5RN-F cable 1.5 metre (5 Metre EU)

### 4 Models available:

 LIGHT OUTPUT	<b>800</b> LUMENS	<b>1500</b> LUMENS	<b>2500</b> LUMENS	<b>4000</b> LUMENS
 Beam	<b>10</b> METRES	<b>15</b> METRES	<b>25</b> METRES	<b>30</b> METRES
 220V -240V AV	<b>DIMENSIONS</b> 192mm x171mm x52mm	<b>DIMENSIONS</b> 220mm x2194mm x52mm	<b>DIMENSIONS</b> 255mm x285mm x63mm	<b>DIMENSIONS</b> 355mm x302mm x63mm
 IP54 RATING	 <b>0.83</b> KG	 <b>1.09</b> KG	 <b>1.66</b> KG	 <b>2.16</b> KG

PRODUCT CODE: NSWORKBRITE800/EU  
 PRODUCT CODE: NSWORKBRITE1500/EU  
 PRODUCT CODE: NSWORKBRITE2500/EU  
 PRODUCT CODE: NSWORKBRITE4000/EU



# NEW Festoon Lights

## AC LED Cable Lights 22 Metres, 110V, 16A

The Festoon LED work lights are ideal AC work lights for Industrial, construction applications. The 110V LED Festoon lighting is energy efficient, saving up to 80% electrical power making them a cost effective lighting solution for indoor and outdoor use.



X10 LED Lamps



22 Metre 2 x 0.75mm yellow arctic grade cable with 16A 110V CEE Plug

### KEY FEATURES:

- 660 lumens per lamp
- Super bright LED lamps - 10 x 660 lumens per kit
- 22 Metre 2 x 0.75mm yellow arctic grade cable
- Lamp holders spaced every 2 metres
- Multiple festoons can be linked to form a longer light chain via a junction box
- IP65 Rating
- Low heat output - Saves 80% electrical power
- Long life LED lamps rated life of 30,000 hours
- Fitted with 16A 110V CEE Plug



PRODUCT CODE: NSFESTOON22M8W



### Optional accessories:

14 Metre extension lead available (110v Only): SPCABLE14M



# NEW Gripper light

## Gripper Inspection Lamp, 110V CEE or 240V AC BS Plug, 60W

This heavy-duty inspection lamp features a 50mm wide clamp with hand grips and a useful hanging hook for hand free working. Ideal for clamping to joists, scaffolding or under car bonnets etc.



240V AC BS plug  
or 110V CEE plug

**3** YEAR  
WARRANTY\*

### KEY FEATURES:

- 240V AC BS plug or 110V CEE plug
- Spring loaded handles for hands-free work
- Tough composite construction
- Bulb mounted in a ceramic holder and protected by a metal grille
- Double insulation construction
- E27 Lamp holder
- Supplied with heavy duty, HO5RN-F cable 1.5 metre

220 or  
110V  
AC

2 X CEE  
SOCKETS

2 X CEE  
SOCKETS

IP20  
RATING

DIMENSIONS  
140mm  
x285mm  
Diameter

1.7  
KG

PRODUCT CODE: NSGRIPPER110V  
PRODUCT CODE: NSGRIPPER240V



# Fast Star Range Designed for fast installation



**3** YEAR  
WARRANTY\*

## Easy and simple installation

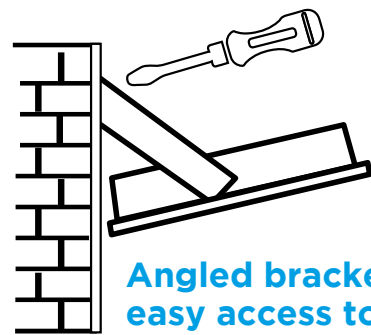

Angled bracket gives easy access to secure onto wall

Designed for quick and simple installation  
2 Ways To Connect To Mains AC Supply:  
Directly Into Internal Terminal Block  
Or  
With Cable Provided Into A Suitable Rated Junction Box.



Up To 90% More Efficient Than Traditional Lighting

Perfect for around the home, providing light to driveways and adding security.

# Fast Star Range

## New Slim Design LED Security Light

The FastStar range has been designed for Fast and Easy installation. It can be connected into its own internal terminal block or alternatively it comes with a pre-wired 30cm cable to connect into a suitable external junction box. It also has a clever angled wall bracket which allows easy fixing without the need to remove the bracket.



120°

3 Models available: 10W, 30W, 50W



Day + Night Auto Sensor



120°



12m Motion Detection

With PIR Sensor

3 Models available: 10W, 30W, 50W

### KEY FEATURES:

- 800-4000 lumens
- 10 to 30 metre beam
- IP65 Rating
- Aluminium housing
- Touch glass lens
- Slimline compact design
- Anti glare cover
- 6000K cool white colour temperature
- PIR models lights up for 5 minutes when activated



10W

800 LUMENS

10 METRES

DIMENSIONS  
145mm  
x140mm  
x36mm

497g

30W

2400 LUMENS

20 METRES

DIMENSIONS  
175mm  
x170mm  
x47.5mm

925g

50W

4000 LUMENS

30 METRES

DIMENSIONS  
200mm  
x195mm  
x37mm

1.5KG



PRODUCT CODE: NSFASTSTAR10/30/50

PRODUCT CODE: NSFASTSTAR10/30/50PIR

# NEW Wobblelight® JR. LED

## Self-Righting LED 110V AC Site Light

The Wobblelight® JR. is a self-righting work light. Bright, durable, built and designed to withstand use in industrial environments and is virtually indestructible. This versatile site light is ideal for industrial construction sites and will illuminate large indoor and outdoor areas.

**360°**  
Illumination

### KEY FEATURES:

- 9,000 lumens
- Patented self-righting technology
- Integrated 1.5 metre power cables
- Rugged construction for long life in the harshest conditions
- Cool operation - no hot surfaces
- Operating temperature: -40°C to 50°C
- Integrated 1.5 metre power cable with CEE 16A plug



NSWOBBLELIGHTJR



Silicon ring for lamp stability



## LED Work Light With 2 x Bluetooth Speakers

The Beat-Lite is a funky little work light, that has a built in bluetooth speaker that allows you to listen to your favourite music while you work. The robust construction makes it ideal for use in any environment, internal or external.



### KEY FEATURES:

- 2,000 lumens
- Integrated 6W Bluetooth speakers
- Play you favourite music while you work
- IP44 Rating suitable for use outdoors
- Simple connection
- 20 metre flood beam
- Robust housing

LIGHT OUTPUT	<b>2000 LUMENS</b>		
Beam	<b>20 METRES</b>		
220 - 240V AC	IP44 RATING	DIMENSIONS 239mm x78mm x252mm	1.75 KG

PRODUCT CODE: NSBEATLITE

**Bluetooth**  
MUSIC WHILE YOU WORK



Bluetooth connection allows easy connection to smart phones, MP3 Players and tablets

**3 YEAR WARRANTY\***



Optional tripod available  
SPTRIPOD1.7

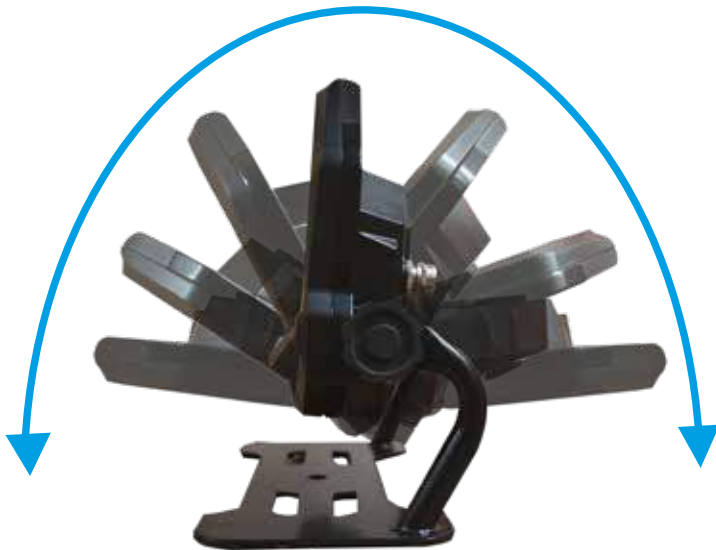

280° Pivoting Head





# Hi-Star - Energy Saving Range

## AC Mains LED High Bay Light

The Hi-Star is designed to be used in industrial areas, warehouses and retail areas. Ideal for both new projects or retrofit solutions. Providing superior illumination with excellent energy savings and provides years of maintenance free service. There is no warm up time with the Hi-Star LED units and the lifespan is not affected by switching on and off.



### KEY FEATURES:

- Powerful 21,000 to 28,000 lumens
- Instant Light - No warm up
- Sleek compact design
- Excellent energy savings
- Tempered clear glass protector & steel bracket
- Ultra low power consumption
- 50,000 hour rated life
- Ideal for warehouse, workshops & car parks
- 6000K cool white colour temperature
- Robust aluminium casing
- Maintenance free

2 Models available:  
150W (1800 lumens)  
or 200W (2400 lumens)



150W  
21,000  
LUMENS

DIMENSIONS  
273mm  
x95mm  
Diameter

1.79  
KG

200W  
28,000  
LUMENS

DIMENSIONS  
360mm  
x133mm  
Diameter

2.45  
KG

110 -  
240V  
AC

IP65 RATING  
WATERPROOF

PRODUCT CODE: NSHISTAR150  
NSHISTAR200

EPISTAR  
LED CHIP

3  
YEAR  
WARRANTY\*

Die-casting aluminium for  
heat dissipation



Typical energy savings would be in excess of 85%  
compared to metal halide with an  
average payback period of less than 1 year



## Professional Rechargeable 12,760 Lumen Searchlight

The ProStar has been very thoughtfully designed for Emergency situations and is ideal for both Search and Rescue and Scenes of Crime operations. With its dual optics and reflective system it is perfect for long distance searching and for wide area floodlighting and now with its newly improved power it delivers an amazing 12,760 lumens of light.



**UPGRADED  
VERSION  
12,760  
LUMENS**

**3  
YEAR  
WARRANTY**

### KEY FEATURES:

- Light power 12,760 lumens
- Long distance spot beam
- Wide angled flood beam
- 14.8V 10.2Ah Li-ion maintenance free battery
- 9 Light modes with up to 20 hours operation
- Swivel head for multiple head angle position
- Battery status and charging indicator
- Wall mountable charging base
- Rubberised handle for comfortable non slip grip
- Rubberised light front and base to give added strength and stability
- One hand operation
- Comfortable shoulder strap
- 6 Hours charging time
- Robust housing
- Anti slip rubberised base with built in stability

Long distance spot beam

Wide angled flood beam



Adjustable swivel head

	BOOST	SEARCH	FLOOD	
LIGHT OUTPUT	<b>12,760</b> LUMENS	<b>6,000</b> LUMENS	<b>7,000</b> LUMENS	
Beam	<b>1,200</b> METRES			
	<b>1hrs 20min</b>	<b>20hrs</b>	<b>11hrs 30min</b>	
RECHARGEABLE <b>LITHIUM</b> BATTERY	IP65 RATING WATERPROOF	CHARGING TIME 6 HRS	DIMENSIONS 280mm x160mm 120mm	<b>1.8 KG</b>

PRODUCT CODE: NSPROSTAR

Supplied with: AC adaptor, charging base and shoulder strap

**Long Distance Searchlight, Ideal For Search + Rescue**



**Wide Angled Floodlight, Ideal For Scenes Of Crime**



Mode		Lumens	Runtime
Boost	Search + Flood Full	12,760	1 hours 20 minutes
Search	Full	6,000	2 hours 30 minutes
	Half	3,000	7 hours 45 minutes
	Low	1,200	20 hours
Flood	Full	7,000	4 hours 30 minutes
	Half	3,000	11 hours 30 minutes
Dimmable	Full	6,000	6 hours 30 minutes
	Half	12,000	78 hours



Scan to see the ProStar in Action

[Video Link](#)

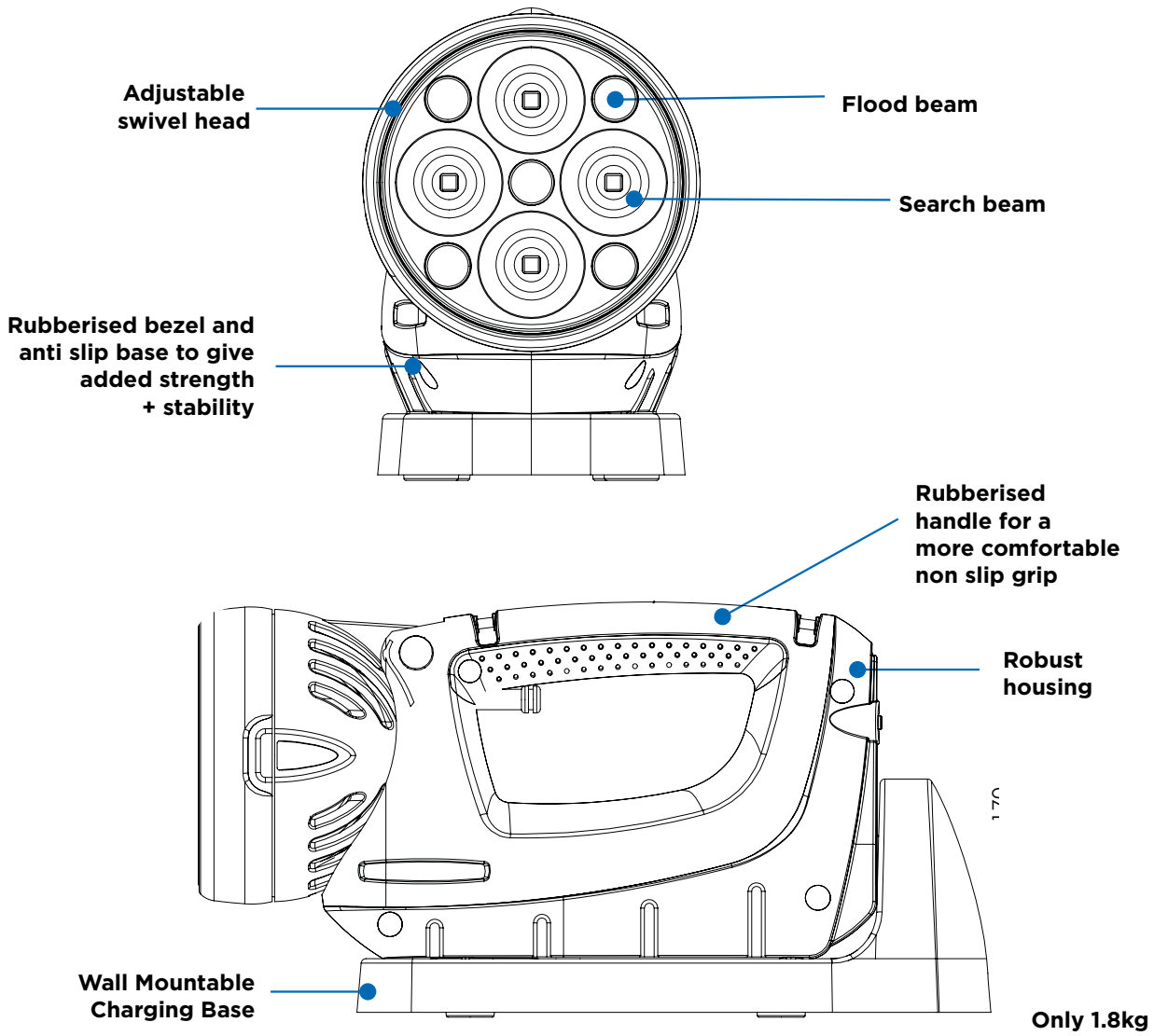

# NEW Panther XHP-X

## Professional Rechargeable Searchlights

The PANTHER XHP-X has now upgraded with the latest LED technology increasing the running time to 3hrs on full and 8hrs on half power. The unique deep dish reflector enables maximum distance to lumen ratio achieving a 1000m beam from only 1,800 lumens; weighing under 1kg it is our lightest in the range and offers exceptional value for money.

**3** YEAR WARRANTY\*

**UPGRADED VERSION  
1800 LUMENS**



	HIGH	LOW
<b>LIGHT OUTPUT</b>	<b>1800 LUMENS</b>	<b>750 LUMENS</b>
<b>Beam</b>	<b>1000 METRES</b>	<b>500 METRES</b>
<b>Runtime</b>	<b>3hrs</b>	<b>8hrs</b>
<b>RECHARGEABLE LITHIUM BATTERY</b>	<b>IP54 RATING</b>	<b>CHARGING TIME 9HRS</b>
<b>DIMENSIONS 260mm x150mm 180mm</b>	<b>1 KG</b>	

PRODUCT CODE: NSPANTHERXHP-X  
CAT/PAD: 0111/108311

### KEY FEATURES:

- 1,800 Lumens
- 1000 metre beam
- Runs up to 8 hours
- Lightweight design
- Rechargeable lithium battery - 7.4V 4.4Ah
- Robust polyethylene construction
- Virtually unbreakable casing
- Unique deep dish reflector
- Battery charging indicator
- Supplied with: AC & adjustable stand

### Optional accessories:



Vehicle Charger:  
CHIC8.4-LI-ION



Vehicle/Wall Mounting Bracket:  
SPPANBRACKET



Vehicle Charging Bracket:  
CHICPANTHERXHPCHBRACKET



Coloured Filters:  
SPPANTHERA/B/G/R



## Small, Compact Rechargeable Searchlights

The rechargeable PUMA is a lightweight and compact alternative of the PANTHER, used for professional applications by Emergency Services and Utility Companies. Used in all weather conditions, the Puma is virtually unbreakable, incorporating a toughened glass lens and a shock resistant polyethylene plastic case.



### KEY FEATURES:

- 800 Lumens
- 400 metre beam
- Runs up to 7 hours
- Lightweight design
- Rechargeable lithium battery - 3.7V 4.4Ah
- 2 Position adjustable handle
- Powerful CREE XML LEDs
- Unique deep dish reflector
- Robust polyethylene construction
- Virtually unbreakable casing
- Attachable wrist strap
- Battery charging indicator
- Supplied with AC Mains charger, shoulder carrying strap



Wide light beam  
Ideal for Emergency Services,  
Utility Company applications

	HIGH	LOW		
	800 LUMENS	400 LUMENS		
	800 METRES	400 METRES		
	3hrs	7hrs		

PRODUCT CODE: NSPUMAXML  
CAT/PAD: URLT/010412

### Optional accessories:



Vehicle Charger:  
CHIC8.4-LI-ION



Vehicle/Wall  
Mounting Bracket:  
SPPANBRACKET



Vehicle Charging  
Bracket:  
CHICPUMAXMLBASE



110 mm  
Diffused Lens:  
SPLENS110-DIF



Coloured Filters:  
SPPUMAA/B/G/R







# Trio-550

## Rechargeable LED Search Light

The TRIO-550 has a long range beam of up to 500m, the TRIO 550 is ideal for Patrolling, Security Guards, Search & Rescue, and with robust construction it's durable enough for all applications. The TRIO 550 features an emergency function to automatically illuminate in the event of a power cut. It can be mounted on walls or in vehicles using the bracket supplied.



2 Models available:  
Hi Viz Yellow or Grey and Blue

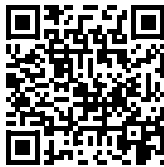

Video Link

### KEY FEATURES:

- 550 Lumens
- 600 metre beam
- Runs up to 15 hours
- Lightweight design
- Rechargeable lithium battery - 3.7V 16.65W 4500mAh
- USB output - Can charge phone
- Tough durable construction, Polycarbonate lens
- 3 x CREE LEDs XP-G2 cool white
- Water and shock resistant
- Can be mounted on walls or in vehicle
- Supplied with Wall mount, USB cable, USB 12V-24V car charger, Shoulder strap, AC USB mains adaptor

Emergency function to automatically illuminate in the event of a power cut



	HIGH	LOW	FLASHING	
LIGHT OUTPUT	550 LUMENS	275 LUMENS	550 LUMENS	
Beam	600 METRES	300 METRES	600 METRES	
	3hrs	7hrs	15hrs	
RECHARGEABLE LITHIUM BATTERY	IP54 RATING	CHARGING TIME 10HRS	DIMENSIONS 193mm x117mm 132mm	650 g

PRODUCT CODE:  
NSTRIO550Y (YELLOW+GREY)  
NSTRIO550 (GREY+BLUE)

## Rechargeable LED Search Light

This SoloStar is an ultra lightweight searchlight, it is highly visible in its surroundings due to the green robust polypropylene plastic housing. Ideal for most outdoor adventures such as camping, hiking, walking the dog as well as professional use in horticultural and construction sectors. Includes a built-in powerbank, so can easily charge your mobile phone or tablet on the go!



Video Link

### KEY FEATURES:

- 450 Lumens
- 500 metre beam
- Runs up to 12 hours
- Lightweight design
- Rechargeable lithium battery - 3.7V 4000mAh
- Powerbank - Can charge your phone
- Powerful CREE XP-G LEDs
- High visibility colour
- Robust polypropylene plastic housing
- Battery charging indicator

	HIGH	LOW	
LIGHT OUTPUT	450 LUMENS	150 LUMENS	
Beam	500 METRES	250 METRES	
	4hrs	12hrs	
RECHARGEABLE LITHIUM BATTERY	IP44 RATING	CHARGING TIME 12HRS	DIMENSIONS 209mmx 133mm 125mm
			400 g

PRODUCT CODE: NSOOSTAR

Supplied with AC & vehicle charger

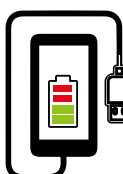

**Power Bank  
Charge Your Phone  
Using The USB Socket**



Counter top display

# Trigger Pro

## Rechargeable LED Search Light

The Trigger Pro is the first lightweight LED alternative to 2-3 million candle power halogen searchlights, which are very inefficient. The unique deep reflector system combined with high intensity Cree® LED provide a spot beam are able to cover up to a 1000 metres.











Battery status and charging indicator



### KEY FEATURES:

- 1,000 Lumens
- 700 metre beam
- Runs up to 15 hours
- Lightweight design
- Rechargeable lithium battery (3.7V 3600mAh)
- Powerful CREE XPL LED
- Unique deep dish reflector
- Rubberised handle for comfortable grip
- Robust polycarbonate construction
- Virtually unbreakable casing
- Micro USB charging port
- Battery status and charging indicator
- One hand trigger operation
- Supplied with Wrist strap, micro USB cable, 12V vehicle charger, USB mains adaptor

	HIGH	LOW	STROBE
 LIGHT OUTPUT	1000 LUMENS	700 LUMENS	1000 LUMENS
 Beam	700 METRES	200 METRES	
	3hrs 40MINS	15hrs	
 RECHARGEABLE LITHIUM BATTERY	 IPX4 RATING	 CHARGING TIME 5HRS	 DIMENSIONS 293mm x90mm Diameter
			 700g

PRODUCT CODE: NSTRIGGERPRO  
CAT/PAD: 0111/113529

### Optional accessories:



AC Adaptor:  
CH-USB-UK



**Professional Rechargeable Searchlights**

The SL360 has now upgraded with the latest LED to the SL360 increasing the running time to 12hrs on full power. The deep dish reflector enables maximum distance to lumen ratio, increasing the beam distance to 400 metres. The robust casing is drop, shock and water resistant and includes an integrated adjustable stand and swivel handle (adjustable through 90°) allowing a pistol grip for searchlight applications or a carry handle.



Carry handle position

**KEY FEATURES:**

- 360 Lumens
- 400 metre beam
- Runs up to 12 hours
- Lightweight design
- Rechargeable lithium battery - 3.7V 4400mAh
- 2 Position adjustable handle
- Powerful CREE XP-G LEDs
- Robust construction
- Battery level indicator
- Adjustable stand
- Supplied with AC & vehicle chargers

**UPGRADED  
VERSION  
360  
LUMENS**

**3  
YEAR  
WARRANTY\***

	<b>HIGH</b>	<b>LOW</b>		
	<b>360 LUMENS</b>	<b>140 LUMENS</b>		
	<b>400 METRES</b>	<b>200 METRES</b>		
	<b>4hrs</b>	<b>12hrs</b>		
	<b>IP44 RATING</b>	<b>CHARGING TIME 12HRS</b>	<b>DIMENSIONS 184mm x119mm 150mm</b>	<b>469g</b>

PRODUCT CODE: NSSL360

**2 positions of handle**



Adjustable Stand



Pistol handle position

# NEW SL1600

## Professional Rechargeable Searchlights

The SL1600 has now upgraded with the latest LED to the SL1600 increasing the beam distance to 1,000 metres. This LED searchlight also features an amber flashlight for emergency or signalling purposes. The robust casing is drop, shock and water resistant and includes an integrated adjustable stand and swivel handle (adjustable through 90°) allowing a pistol grip for searchlight applications or a carry handle.



Adjustable Stand

### KEY FEATURES:

- 1,600 Lumens
- 1000 metre beam
- Runs up to 120 hours
- Lightweight design
- Rechargeable lithium battery (7.4V 4400mAh)
- 3 Position adjustable handle
- Deep dish reflector
- Ultra bright XHP50 LEDs
- Adjustable stand
- Flashing amber light mode
- Supplied with AC & vehicle chargers

	HIGH	AMBER FLASHING
LIGHT OUTPUT	1600 LUMENS	14 LUMENS
Beam	1000 METRES	100 METRES
	3hrs	120hrs
RECHARGEABLE LITHIUM BATTERY	IP44 RATING	CHARGING TIME 6HRS
	DIMENSIONS 226x165 179mm Diameter	1.03 KG

PRODUCT CODE: NSSL1600

UPGRADED  
VERSION  
1600  
LUMENS

3  
YEAR  
WARRANTY\*



3 positions of handle



Power Bank  
Charge Your Phone  
Using The USB Socket



Amber flashlight for  
emergency or  
signalling purposes

# NightSearcher New Lighting Technology Zoom Flashlights

NightSearcher are proud to introduce the new Zoom range. Our most advanced range of spot-to-flood flashlights yet.



## SPOT

Narrow long-distance spot beam



## FLOOD

Powerful wide flood beam



ZOOM-1000R Zoom Flashlight





## NEW Zoom 110R

Spot to Flood Zoom Rechargeable Flashlight  
110 lumens

### KEY FEATURES:

- Powerful 110 Lumens
- 35 metre beam
- Runs up to 16 hours
- Advanced optical focus systems
- Rechargeable lithium battery - 3.7V 320mAh
- Knurled grip
- Aluminium housing - Type III hard anodised
- Ultra Bright LED
- Pocket/belt clip
- 3 mode tail cap tactical switch
- Magnetic Base
- Supplied with USB charging cable

	HIGH	MEDIUM	LOW	
LIGHT OUTPUT	110 LUMENS	55 LUMENS	10 LUMENS	
Beam	35 METRES	22 METRES	10 METRES	
	2hrs 30MIN	5hrs 30MIN	16hrs	
RECHARGEABLE LITHIUM BATTERY	IP64 RATING	CHARGING TIME 1.5HRS	52g	Dimensions 128mm x18mm Diameter

PRODUCT CODE: NSZOOM110R



## NEW Zoom 1000R

Spot to Flood Zoom Rechargeable Flashlight, 1000 lumens

### KEY FEATURES:

- Powerful 1000 Lumens
- 210 metre beam
- Runs up to 50 hours
- Advanced optical focus systems
- Rechargeable lithium battery - 3.7V 2600mAh
- Knurled grip
- Aluminium housing - Type III hard anodised
- Ultra Bright XP-L CREE LED
- 5 mode tail cap tactical switch
- Supplied with USB charging cable and wrist strap

	BOOST	HIGH	MEDIUM	LOW	FLASHING
LIGHT OUTPUT	1000 LUMENS	500 LUMENS	200 LUMENS	50 LUMENS	8HZ
Beam	210 METRES	145 METRES	95 METRES	50 METRES	
	4hrs	7hrs	15hrs	50hrs	
RECHARGEABLE LITHIUM BATTERY	IP66 RATING	CHARGING TIME 4HRS	166g	DIMENSIONS 141mm x29mm Diameter	

PRODUCT CODE: NSZOOM1000R



Battery status indicator

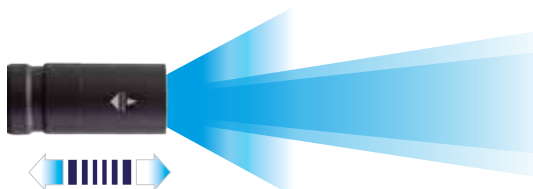

Spot - Flood  
Zoom Beams

### OPTIONAL ACCESSORIES:



12/24V Vehicle Charger:  
CHIC3\_7-Lithium



AC Adaptor:  
CH-USB-UK



EU Adaptor:  
CH-USB-EU



## NEW Zoom 370

Spot to Flood Zoom Flashlight  
370 lumens

### KEY FEATURES:

- 370 Lumens
- 175 metre beam
- Runs up to 60 hours
- Advanced optical focus systems
- Knurled grip
- Aluminium housing - Type III hard anodised
- Ultra Bright CREE XP-G2 LED
- 5 mode tail cap tactical switch
- Supplied with 2 x AA alkaline batteries and wrist strap

	BOOST	HIGH	MEDIUM	LOW	FLASHING
LIGHT OUTPUT	370 LUMENS	260 LUMENS	130 LUMENS	30 LUMENS	8HZ
Beam	175 METRES	145 METRES	105 METRES	50 METRES	
	2hrs	5hrs	13hrs	60hrs	
2xAAA BATTERY					
IP65 RATING					
150g					
DIMENSIONS 158mm x 29mm Diameter					

PRODUCT CODE: NSZOOM370



## NEW Zoom 500

Spot to Flood Zoom Flashlight  
500 lumens

### KEY FEATURES:

- 500 Lumens
- 285 metre beam
- Runs up to 45 hour
- Advanced optical focus systems
- Knurled grip
- Aluminium housing - Type III hard anodised
- Ultra Bright CREE XP-G2 LED
- 5 mode tail cap tactical switch
- Supplied with 4 x AAA alkaline batteries and wrist strap

	BOOST	HIGH	MEDIUM	LOW	FLASHING
LIGHT OUTPUT	500 LUMENS	300 LUMENS	150 LUMENS	20 LUMENS	8HZ
Beam	285 METRES	230 METRES	165 METRES	65 METRES	
	1hrs	2hrs	6hrs 30MIN	45hrs	
4xAAA BATTERY					
IP66 RATING					
172g					
DIMENSIONS 129mm x 38mm Diameter					

PRODUCT CODE: NSZOOM500

Spot - Flood  
Zoom Beams

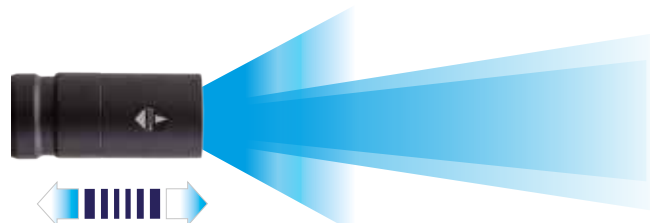



# Explorer-1000

## Rechargeable Led Tactical Flashlight, 1000 lumens

The Explorer-1000 is a professional rechargeable, LED tactical flashlight with a 600 metre spot beam and 1000 lumens light output with 6 light modes! You can easily cycle through the light modes using the tail cap tactical switch or one on the body, there is also a 'through switch' battery status indicator. The flashlight is type III anodised aluminium and incorporates a secure grip, and has a 1.5m impact resistance.



Through Switch  
Battery Status + Charging Indicator

### KEY FEATURES:

- 1,000 Lumens
- 600 metre beam
- Runs up to 50 hours
- Rechargeable lithium battery - 3.7V 2600mAh
- Aluminium housing - Type III hard anodised
- Ultra Bright CREE XLAMP XML U2 LED
- 2 Hidden light modes: Strobe/SOS
- Knurled grip
- 2 switches - tail cap tactical and body
- Through switch battery status indicator
- Supplied with USB charging cable



	100%	60%	30%	5%	STROBE/SOS
LIGHT OUTPUT	1000 LUMENS	600 LUMENS	300 LUMENS	50 LUMENS	1000 LUMENS
Beam	600 METRES	445 METRES	300 METRES	175 METRES	600 METRES
	2hrs 36MIN	4hrs 18MIN	8hrs 30MIN	50hrs	2hrs 40MIN
RECHARGEABLE LITHIUM BATTERY	IPX7 RATING	CHARGING TIME 6HRS	200g	DIMENSIONS 165mm x 36mm Diameter	

PRODUCT CODE: NSEXPLORER1000

Optional accessories:

- 12/24V Vehicle Charger: CHIC3\_7-Lithium
- USB Charging Adaptor: CH-USB-EU



**NEW** **Magnum-1100**

**Rechargeable flashlight with long distance spot beam, 1100 lumens**

The Magnum-1100 is a professional rechargeable, LED flashlight. It has a staggering spot beam of 1100 metres powered from the 1100 lumens, super bright Cree® LEDs. The flashlight has 5 light modes making this torch suitable for almost any situations. The tough body is made from type III anodised aluminium housing and ideal for security, emergency services, scenes of crime, search and rescue sectors.



Transportation Lock - prevents the light from being turned on accidentally

**KEY FEATURES:**

- 1,100 Lumens
- 1,100 metre beam
- Runs up to 26 hours
- Rechargeable lithium battery 7.4V 2600mAh or 3 x C alkaline batteries (not included)
- Aluminium housing - Type III hard anodised
- Ultra Bright CREE XHP70 N4 LED
- Transportation Lock - prevents the light from being turned on accidentally
- Knurled grip
- Battery status and charging indicator
- Supplied with mains charger and carry strap

	BOOST	HIGH	MEDIUM	LOW	FLASHING
LIGHT OUTPUT	1100 LUMENS	600 LUMENS	350 LUMENS	100 LUMENS	8Hz
Beam	1,100 METRES	760 METRES	620 METRES	315 METRES	
	1hrs 30MIN	8hrs	13hrs	26hrs	8hrs
RECHARGEABLE LITHIUM BATTERY	IP67 RATING	CHARGING TIME 6HRS	835g	DIMENSIONS 265mm x90mm Diameter	

PRODUCT CODE: NSMAGNUM1100



# Magnum-3500

## Rechargeable flashlight with wide flood beam, 3500 lumens

Magnum-3500 rechargeable LED torch is a professional flashlight. It has a staggering 3500 lumen light output with a 700 metre beam, coming from super bright Cree® XHP70 LEDs. Ideal for security, emergency services, scenes of crime, search and rescue sectors.



### KEY FEATURES:

- 3,500 Lumens
- 700 metre beam
- Runs up to 290 hours
- Rechargeable lithium battery - 3.7V 5000mAh
- Aluminium housing - Type III hard anodised
- Ultra Bright CREE XHP70 N4 LED
- 7 light modes: Strobe/SOS
- Knurled grip
- Memory function
- Through switch battery status indicator
- Supplied with USB charging cable

	100%	30%	15%	2%	2%	STROBE/SOS
LIGHT OUTPUT	3500 LUMENS	1200 LUMENS	450 LUMENS	90 LUMENS	13 LUMENS	1000 LUMENS
Beam	700 METRES	560 METRES	420 METRES	195 METRES	145 METRES	
	1hrs	1hrs 54MIN	4hrs 30MIN	29hrs	290 hrs	1hrs 9MIN
RECHARGEABLE LITHIUM BATTERY	IPX8 RATING	CHARGING TIME 6HRS	470g	DIMENSIONS 293mm x67mm Diameter		

PRODUCT CODE: NSMAGNUM3500

### Optional accessories:

- 12/24V Vehicle Charger: CHIC3\_7-Lithium
- USB Charging Adaptor: CH-USB-EU

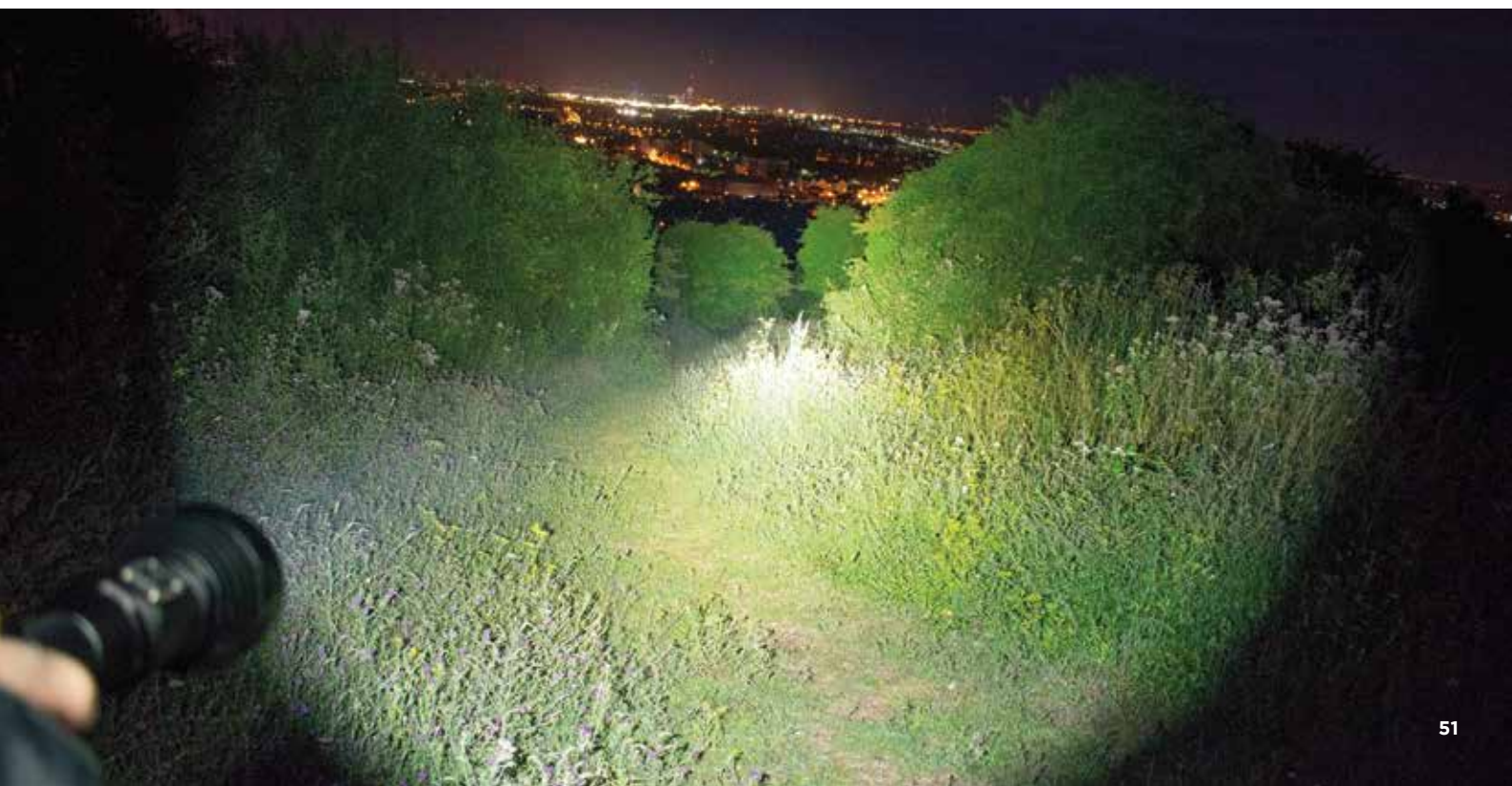

# NEW Magnum-11600

## NS Most Powerful Rechargeable Flashlight, 11600 lumens

The NightSearcher Magnum offers a staggering 11,600 lumen output, making it NightSearcher's most powerful rechargeable flashlight. The Ultra bright XHP CREE LEDs and will last for 3 hours on the Boost setting. Ideal for security, emergency services, scenes of crime, search and rescue sectors.



**3** YEAR WARRANTY\*

Transportation Lock - prevents the light from being turned on accidentally

### KEY FEATURES:

- 11,600 Lumens
- 525 metre beam
- Runs up to 54 hours
- Ultra bright 4 x XHP CREE White LEDs
- Rechargeable lithium battery - 7.4V 7800mAh or 3 x C alkaline batteries (not included)
- Aluminium housing - Type III hard anodised
- Ultra Bright CREE XHP70 N4 LED
- Transportation Lock - prevents the light from being turned on accidentally
- Rotational light mode dial
- Knurled grip
- Battery status and charging indicator
- Supplied with mains charger and carry strap

	BOOST	HIGH	MEDIUM	LOW	ECO	FLASHING
LIGHT OUTPUT	<b>11,600</b> LUMENS	<b>5000</b> LUMENS	<b>1500</b> LUMENS	<b>600</b> LUMENS	<b>180</b> LUMENS	<b>8Hz</b>
Beam	<b>525</b> METRES	<b>315</b> METRES	<b>178</b> METRES	<b>154</b> METRES	<b>62</b> METRES	
	<b>3hrs</b>	<b>4hrs</b>	<b>7hrs</b>	<b>15hrs</b>	<b>54hrs</b>	<b>15hrs</b>
RECHARGEABLE LITHIUM BATTERY	IP67 RATING	CHARGING TIME 9HRS	1.235 KG	DIMENSIONS 273mm x95mm Diameter		

PRODUCT CODE: NSMAGNUM11600



# Explorer XML-X

## Rechargeable, Robust, High Powered LED Flashlight, 600 lumens

The Explorer XML-X is a robust LED flashlight, ideal for domestic, security and emergency use. The flashlight comes complete with a wall mounted charging bracket which will automatically illuminate in the event of a power cut. A red cone is included in the box, ideal for traffic management and can be used as a warning light.



In The Event Of A Power Cut 6 White LEDs Will Illuminate Automatically

The Explorer XML-X Comes Complete With Wall Mounting Charging Bracket



Includes a red cone for signalling

### KEY FEATURES:

- Powerful 600 Lumens
- 500 metre beam
- Runs up to 15 hours
- Rechargeable lithium battery - 3.7V 2200mAh
- Wall mounted charging bracket
- 2 mode tail light tactical switch
- Compact and light weight flashlight
- Water and shock resistance
- Powerful CREE XML LEDs
- Battery level indicator
- Robust aluminium housing
- Shatterproof polycarbonate lens
- Supplied with Wall mounting charging bracket, red cone, power cable, AC mains charger

	HIGH	LOW	FLASHING/SOS
LIGHT OUTPUT	600 LUMENS	60 LUMENS	1000 LUMENS
Beam	500 METRES	50 METRES	600 METRES
	1hrs 30MIN	15hrs	
RECHARGEABLE LITHIUM BATTERY	IP65 RATING	CHARGING TIME 6HRS	DIMENSIONS 120mm x190mm 70mm
			280g

PRODUCT CODE: NSEXPLORERXML-X



Optional accessories:



Vehicle Charger: CHICEXPLORER-XML

# NIGHTSEARCHER NEW LIGHTING TECHNOLOGY NAVIGATOR RANGE

## Lock mode

Hold down light mode switch to lock the flashlight. Whilst flashlight is off; hold down button for 5 seconds to lock. To unlock the flashlight; hold down button for 5 seconds.

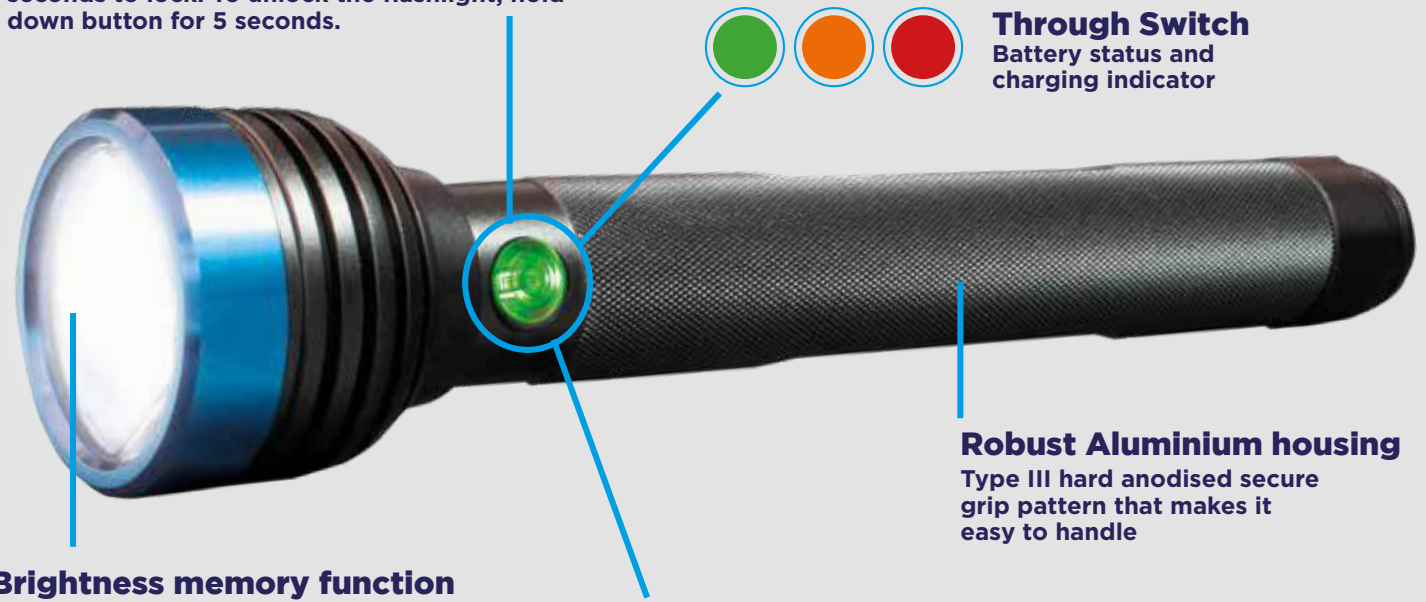

**Through Switch**  
Battery status and charging indicator

## Robust Aluminium housing

Type III hard anodised secure grip pattern that makes it easy to handle

## Brightness memory function

Previous brightness level setting will always be memorised and will resume when torch's light is switched back on again.

## Dimming function

Hold down light mode switch to dim or brighten. When lightest/darkest limits are reached whilst dimming the light will flash twice.

## Navigator 310

Ultra Bright LED Flashlight, 310 lumens



### KEY FEATURES:

- 310 Lumens
- 150 metre beam
- Runs up to 4 hours
- Knurled grip
- Aluminium housing - Type III hard anodised
- Ultra Bright CREE XP-G2 LED
- Through switch battery status and charging indicator
- Brightness memory function
- Dimmable
- 2 x AA alkaline batteries (not included)



**310**  
LUMENS



**150**  
METRES



**4hrs**



**DIMENSIONS**  
161mm  
x26mm  
Diameter



PRODUCT CODE: NSNAVIGATOR310

# Navigator 620R

Ultra Bright LED Rechargeable Flashlight, 620 lumens



**3** YEAR WARRANTY

### KEY FEATURES:

- 620 Lumens
- 175 metre beam
- Runs up to 6 hours
- Rechargeable lithium battery (2x18650/CR123)
- Knurled grip
- Aluminium housing - Type III hard anodised
- Ultra Bright CREE XP-L LED
- Through switch battery status and charging indicator
- Brightness memory function
- Dimmable
- Supplied with USB Charging cable

Optional accessories:  
12/24V Vehicle Charger: CHIC3\_7-Lithium  
USB Charging Adaptor: CH-USB-EU

	<b>620 LUMENS</b>
	<b>175 METRES</b>
	<b>6hrs</b>
	<b>IPX7 RATING</b>
	<b>CHARGING TIME 4HRS</b>
	<b>DIMENSIONS 135mm x 26mm Diameter</b>
	<b>74g</b>

PRODUCT CODE: NSNAVIGATOR620R

# Navigator 1100

Ultra Bright LED Flashlight, 1000 lumens



**3** YEAR WARRANTY

### KEY FEATURES:

- 1,000 Lumens
- 500 metre beam
- Runs up to 8 hours
- Knurled grip
- Aluminium housing - Type III hard anodised
- Ultra Bright CREE XP-L2 LED
- Through switch battery status and charging indicator
- Brightness memory function
- Dimmable
- 4 x C alkaline batteries (not included)

	<b>1000 LUMENS</b>
	<b>500 METRES</b>
	<b>8hrs</b>
	<b>IPX7 RATING</b>
	<b>DIMENSIONS 290mm x 57mm Diameter</b>
	<b>680g</b>

PRODUCT CODE: NSNAVIGATOR1100





# NIGHTSEARCHER NEW LIGHTING TECHNOLOGY KEYSTAR

## Lock mode

Hold down light mode switch to lock the flashlight. Whilst flashlight is off; hold down button for 5 seconds to lock. To unlock the flashlight; hold down button for 5 seconds.

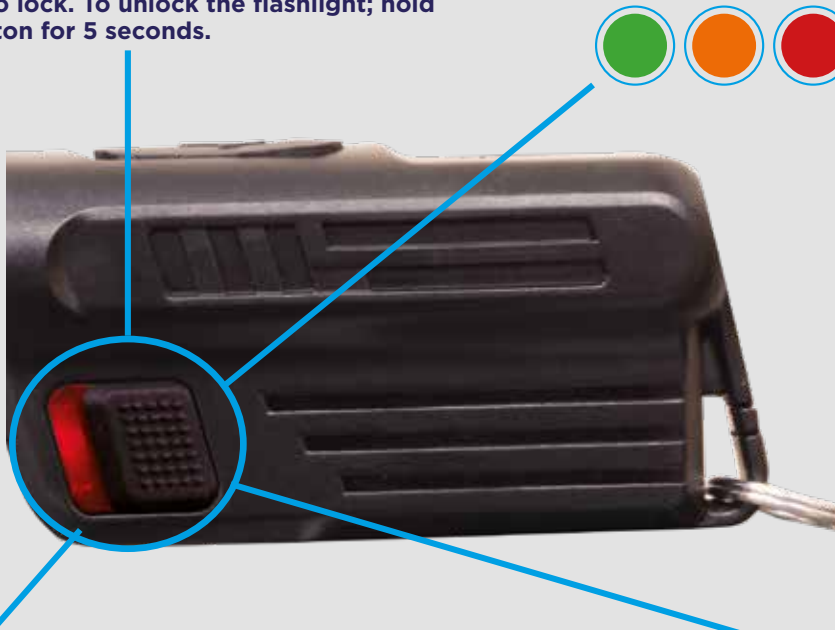

**Through Switch**  
Battery status and charging indicator

## Brightness memory function

Previous brightness level setting will always be memorised and will resume when torch's light is switched back on again.

## Dimming function

Hold down light mode switch to dim or brighten. When lightest/darkest limits are reached whilst dimming the light will flash twice.



**3**  
YEAR  
WARRANTY



## KeyStar

Keychain with searchlight performance  
300 lumens

### KEY FEATURES:

- 300 Lumens
- 110 metre beam
- Runs up to 17 hours
- USB rechargeable lithium battery - 3.7V 600mAh
- Secure grip
- Aluminium housing - Type III hard anodised
- Ultra Bright CREE XP-L LED
- Through switch battery status and charging indicator
- Lock mode (on/off switch)
- Brightness memory function
- Dimmable
- Supplied with USB Charging cable



**300**  
LUMENS



**110**  
METRES



**17hrs**



PRODUCT CODE: NSKEYSTAR

Optional accessories:

12/24V Vehicle Charger: CHIC3\_7-Lithium  
USB Charging Adaptor: CH-USB-EU

# Explorer Pen Light

## Robust Ultra Lightweight Penlight, 160 lumens

The Explorer Penlight is a pocket size LED flashlight, ideal for domestic and professional use. The rechargeable flashlight is made from ultra light, aircraft grade aluminium, while still being robust enough for everyday use. Ideal for inspection and close up work, includes a clip allowing the light to be attached to a shirt or pocket for hands-free usage.



### KEY FEATURES:

- 160 Lumens
- 50 metre beam
- Runs up to 10 hours
- Rechargeable lithium battery - 3.7V 700mAh
- Ultra light aluminium housing
- Ultra Bright CREE XP-G2 R4 LED
- Battery charging indicator
- Pocket sized
- Pocket or belt clip
- Rear tail light switch
- Supplied with USB Charging cable

	HIGH	LOW	STROBE
LIGHT OUTPUT	160 LUMENS	50 LUMENS	160 LUMENS
Beam	50 METRES	25 METRES	50 METRES
	1hrs 30MIN	10hrs	2hrs
RECHARGEABLE LITHIUM BATTERY	IPX4 RATING	CHARGING TIME 2HRS	DIMENSIONS 157mm x17.76mm Diameter

PRODUCT CODE: NSEXPLORERPL

### Optional accessories:

- 12/24V Vehicle Charger: CHIC3\_7-Lithium
- USB Charging Adaptor: CH-USB-EU

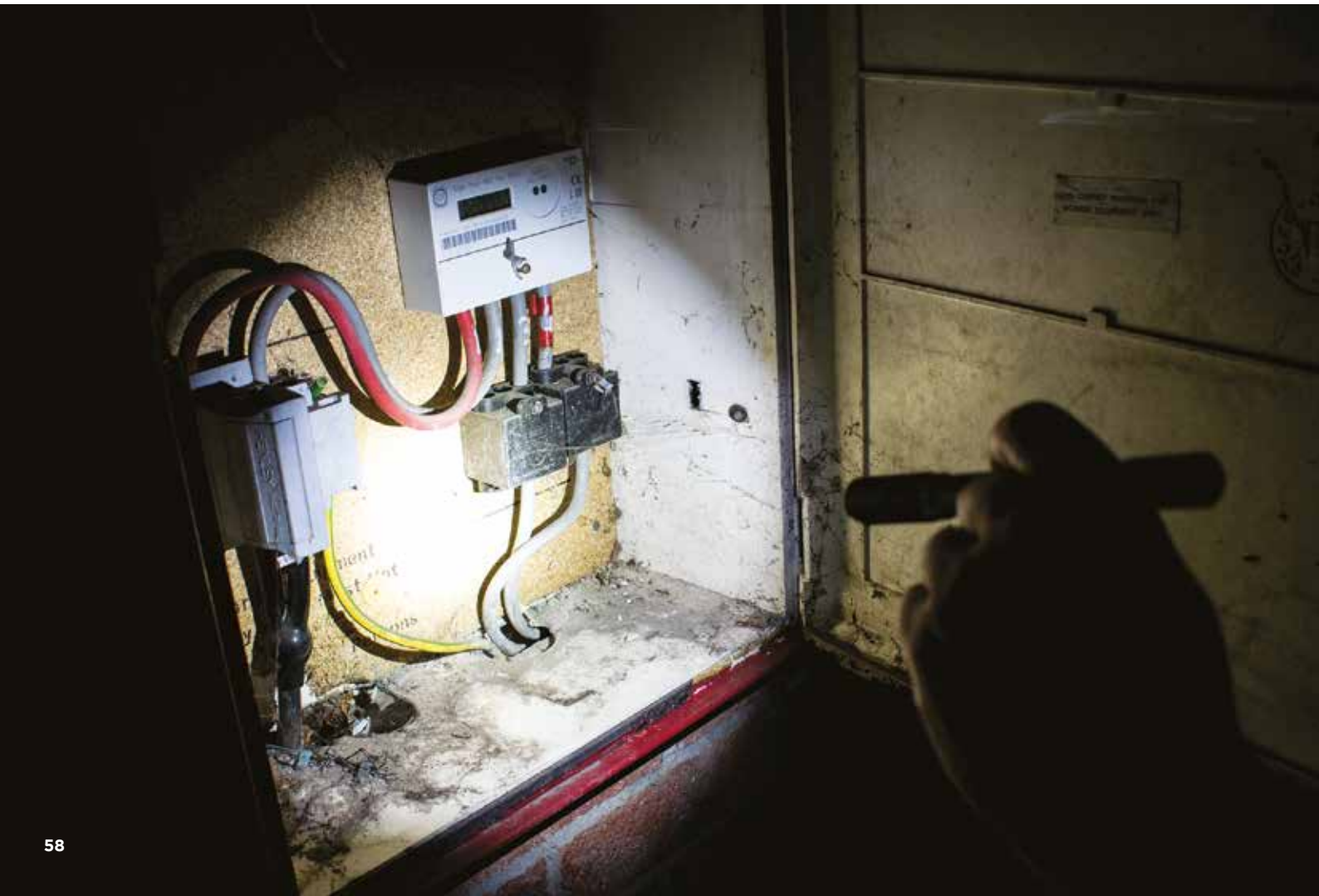

# 18650 USB

## USB Rechargeable Lithium-ion Battery



USB rechargeable  
2600mAh 18650  
lithium-ion battery  
charges in 5 hours

### KEY FEATURES:

- Safety control circuit
- Micro USB port
- Charges in 5 hours
- 18Ø x 70mm
- 47g
- 1 years warranty

PRODUCT CODE: BA18650-USB

### Features charging status indicator



Charged



Charging

### Compatible with the following flashlights and head torches:



NAVIGATOR-620R

1x18650



ZOOM-1000R

1x18650



UV365

1x18650



LIGHTWAVE

1x18650



HT800RX

1x18650



**SPOT**



**FLOOD**

# NEW ZOOM 580R

## Rechargeable Zoom Head Torch, 580 lumens

The ZOOM 580R head torch provides an easy switch from spot to flood beam, simply rotate the bezel to adjust from spot to flood. The Zoom 580R head torch has a unique feature of a removable lithium battery, and can also be used with 3 x AAA alkaline batteries.

### Removable Battery Pack with Charging Indicator



### KEY FEATURES:

- 580 Lumens
- 150 metre beam
- Runs up 18 hours
- Rechargeable lithium battery - 3.7V 800mAh
- Can also work with 3 x AAA alkaline batteries
- Rotate bezel for spot to flood beam
- Cool white zoom beam
- Warm white diffused beam for close up work
- 90° beam angle adjustment
- Adjustable Headband
- Helmet mountable with clips
- Supplied with USB charging cable and rechargeable lithium battery pack

	SPOT TO FLOOD COOL WHITE			CLOSE UP WARM WHITE	
	HIGH	MEDIUM	LOW	LOW	FLASHING
LIGHT OUTPUT	580 LUMENS	270 LUMENS	30 LUMENS	10 LUMENS	2hz
Beam	150 METRES	100 METRES	35 METRES	5 METRES	
	2hrs 30MIN	5hrs 30MIN	18hrs	15hrs	
RECHARGEABLE LITHIUM BATTERY	IP64 RATING	CHARGING TIME 2.5HRS	DIMENSIONS 62mm x41mm x43mm	95g	

PRODUCT CODE: NSHTZOOM580R

### For Longer Running Times This Can be Used With:



3 x AAA Alkaline Batteries



### ZOOM 580

The ZOOM 580 has the same specification as ZOOM 580R headtorch, but supplied with 3 x AAA alkaline batteries.

### Optional accessories:



Helmet Clips: SPPCLIPS



AC Adaptor: CH-USB-UK



12/24V Vehicle Charger: CHIC3\_7-Lithium



EU Adaptor: CH-USB-EU

## Rechargeable Wide Beam Head Torch, 150 lumens

The Light Wave is a rechargeable wide beamed head torch, featuring the option smart on/off wave sensor to switch off the torch with a simple hand gesture. Ideal for when you have dirty glove on site, outdoor activities and pursuits such as fishing, and climbing.

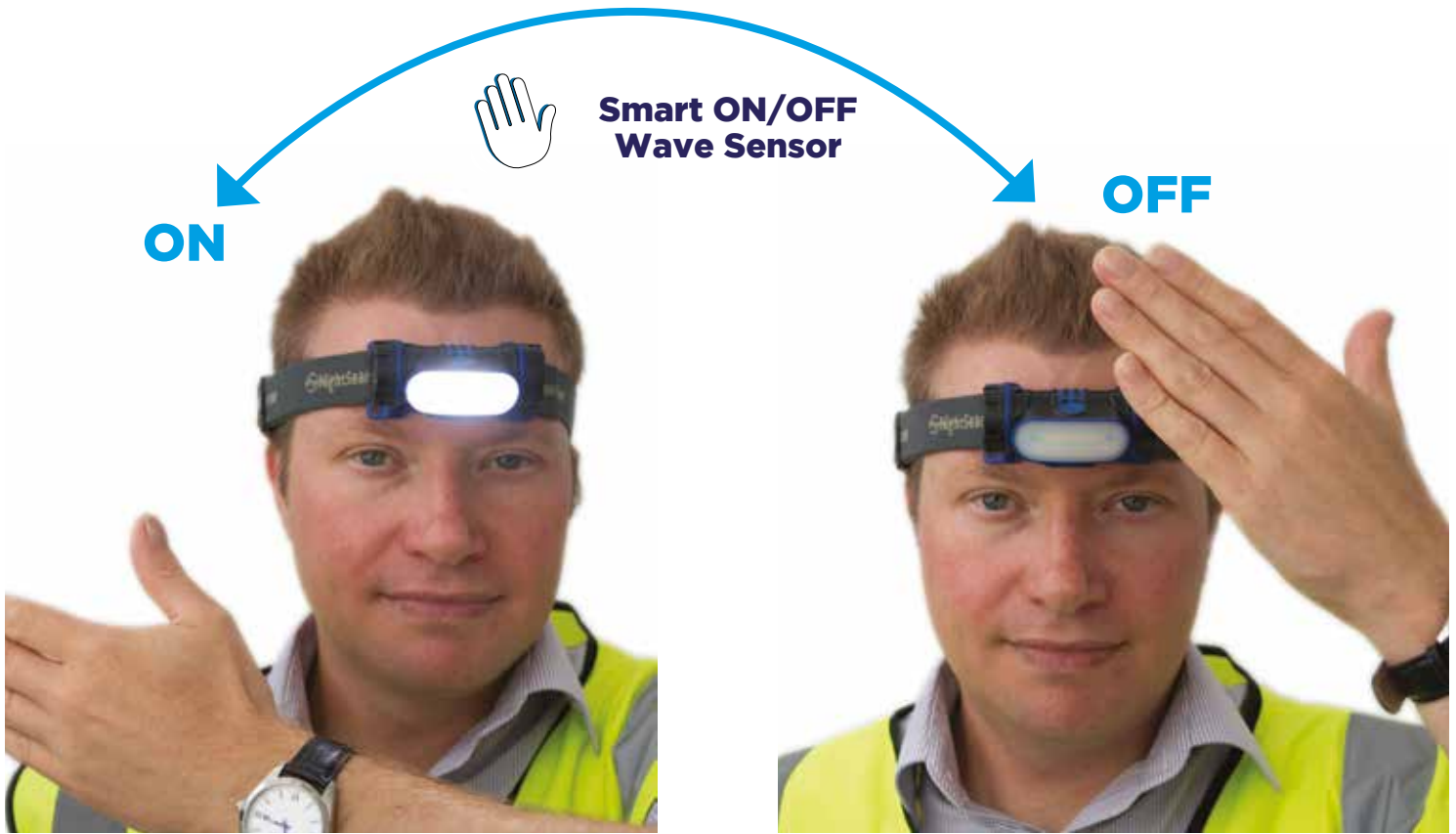

### 2 Ways To Turn ON+OFF

Manually using switch or Intelligent motion sensor.

Touchless wave control. Ideal when hands are dirty, wearing gloves, fishing or climbing

#### KEY FEATURES:

- 150 Lumens
- 20 metre beam
- Runs up 8 hours
- Rechargeable lithium battery - 3.7V 2200mAh
- Wide beam area coverage
- Rechargeable Lithium 3.7V 2200mAh battery
- Battery charging indicator
- Adjustable 180° housing
- Smart sensor indicator
- Motion sensor activated
- Diffused shadow and glare free lens
- Adjustable head strap
- 2 Hour charging time
- Supplied with USB charging cable

	HIGH	LOW
LIGHT OUTPUT	150 LUMENS	75 LUMENS
Beam	20 METRES	10 METRES
	4hrs	8hrs
RECHARGEABLE LITHIUM BATTERY	IP44 RATING	CHARGING TIME 2HRS
	DIMENSIONS 79mm x45mm x35mm	160g

PRODUCT CODE: NSLIGHTWAVE



Wide flood beam

#### Optional accessories:



Helmet Clips: SPPCLIPS



AC Adaptor: CH-USB-UK



EU Adaptor: CH-USB-EU



12/24V Vehicle Charger: CHIC3\_7-Lithium

**Proximity Distance Dimming Head Torch**

The 800RX head torches has the feature of being charged directly into head torch or an optional spare batteries can be purchased separately and charged directly in your car or from your computer. The 800RX uses advanced reactive proximity distance dimming, which automatically changes from spot (long distance) to flood (close up applications).



**KEY FEATURES:**

- 800 Lumens
- 550 metre beam
- Runs up 169 hours
- Rechargeable lithium battery - 3.7V 2600mAh
- Ultra bright CREE XMG2 53 LED
- Battery charging and status Indicator
- Two rear warning light modes
- 90° rotational head
- Safety Lock: Prevents accidental power loss during storage or transportation.
- Wide flood beam
- Adjustable non-slip head straps
- Supplied with USB charging cable

	SPOT + FLOOD	FLOOD HIGH	FLOOD LOW	SPOT HIGH	SPOT LOW
LIGHT OUTPUT	800 LUMENS	494 LUMENS	27 LUMENS	541 LUMENS	29 LUMENS
Beam	550 METRES	500 METRES	250 METRES	500 METRES	250 METRES
	2hrs 30MIN	5hrs	169hrs	5hrs	169hrs
RECHARGEABLE LITHIUM BATTERY	IP66 RATING	CHARGING TIME 5HRS	DIMENSIONS 46mm x85mm x39mm	230g	

PRODUCT CODE: NSHT800RX



Can charge Directly into head torch

**OR**



Optional spare batteries can be purchased separately and charged directly in your car or from your computer

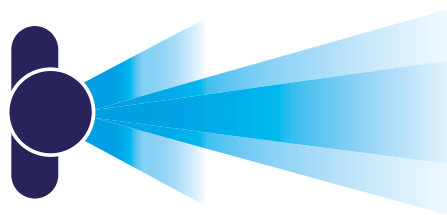

**Proximity Dimming**  
Automatically changes from **SPOT** (Long distance) to **FLOOD** (Close up applications).

**Brightness Memory Function**  
Previous brightness level will be memorized and resume when turned on.

**Optional accessories:**

- Battery: BA18650-USB
- Helmet Clips: SPPCLIPS
- AC Adaptor: CH-USB-UK
- EU Adaptor: CH-USB-EU
- 12/24V Vehicle Charger: CHIC3\_7-Lithium

# NEW Hi-Vis Vest With Light

## USB Rechargeable LED Light

Keep extra safe with NightSearchers Hi-Vis fire retardant EN standard safety vest, with removable LED USB Rechargeable light. The vests are made from high quality material and with an integrated rechargeable LED light which can be removed from the vest and recharged from any USB socket.



### KEY FEATURES:

- 150 lumens
- 14 metre beam
- Runtime 2-4 hours
- Rechargeable Lithium battery
- EN ISO 20471, Class 2 certified safety work wear
- Removable light charging and washing
- 4 x Ultra bright LEDs
- Recharges from any USB socket
- Battery charging indicator

	HIGH	MEDIUM	LOW
LIGHT OUTPUT	150 LUMENS	100 LUMENS	50 LUMENS
TIME	2hrs	3hrs	4hrs
RECHARGEABLE LITHIUM BATTERY	IP65 RATING	CHARGING TIME 4HRS	21g

PRODUCT CODE: NSHIVEST-L/XL/XXL/3XL

4 sizes available: L | XL | XXL | 3XL

SIZE	A	B
L	120-128	160-175
XL	128-136	175-185
XXL	136-144	185-195
3XL	144-152	195-205

Charge in computer or any USB Port



Removable Light For Charging And Washing



The charging indicator will glow red while charging and turn green once charged



# **NEW** Beanie Head Torch

## USB Rechargeable LED Light

The NightSearcher Beanie head torch is supplied with an integral removable rechargeable LED Light. This warm and comfortable knitted hat is perfect for cold long dark winter nights. The light is easily removed for rechargeable from any USB socket. Ideal for electricians, builders, walkers etc.



4 colours available



Red

Yellow

Navy

Black



Removable Light For Charging And Washing



### KEY FEATURES:

- 150 lumens
- 14 metre beam
- Runtime 2-4 hours
- Rechargeable Lithium battery
- Cosy and warm
- One size fits all
- Removable light charging and washing
- 4 x Ultra bright LEDs
- Recharges from any USB socket
- Battery charging indicator

	HIGH	MEDIUM	LOW
LIGHT OUTPUT	150 LUMENS	100 LUMENS	50 LUMENS
	2hrs	3hrs	4hrs
RECHARGEABLE LITHIUM BATTERY	IP65 RATING	CHARGING TIME 4HRS	21g

PRODUCT CODE: NSBEANIE-R/Y/N/B

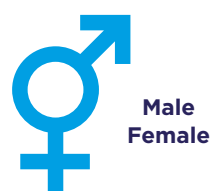

Male  
Female

Charge in computer or any USB Port



The charging indicator will glow red while charging and turn green once charged

# Atex Range

Designed for used for oil & gas, petrochemical, aviation, marine, mining and utility applications.

## Intrinsically Safe Explained

### Hazardous Area Classification Zone 0, Zone 1, Zone 2

This diagram shows how hazardous area zones may occur in typical circumstances

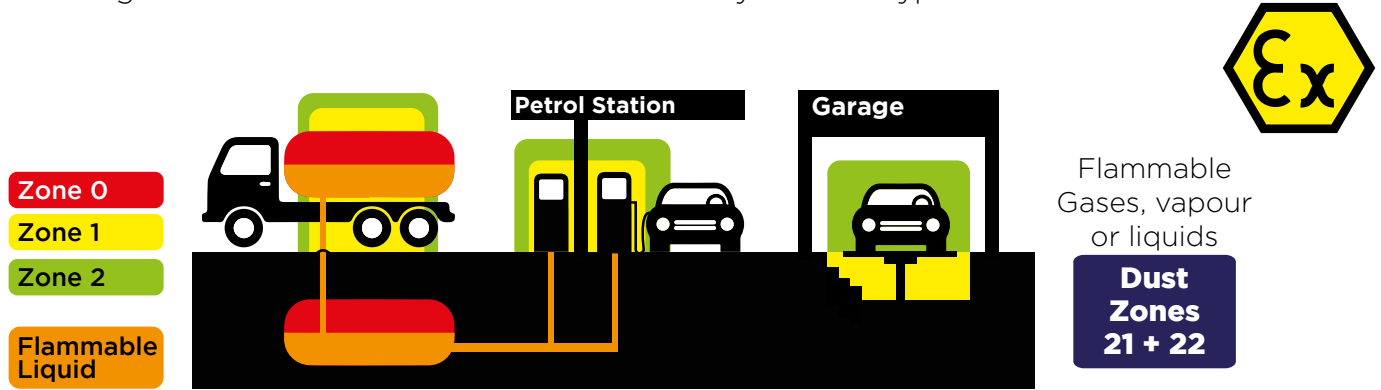

### Hazardous Area Classification Zone 20, Zone 21, Zone 22

This diagram shows how hazardous area zones may occur in typical circumstances

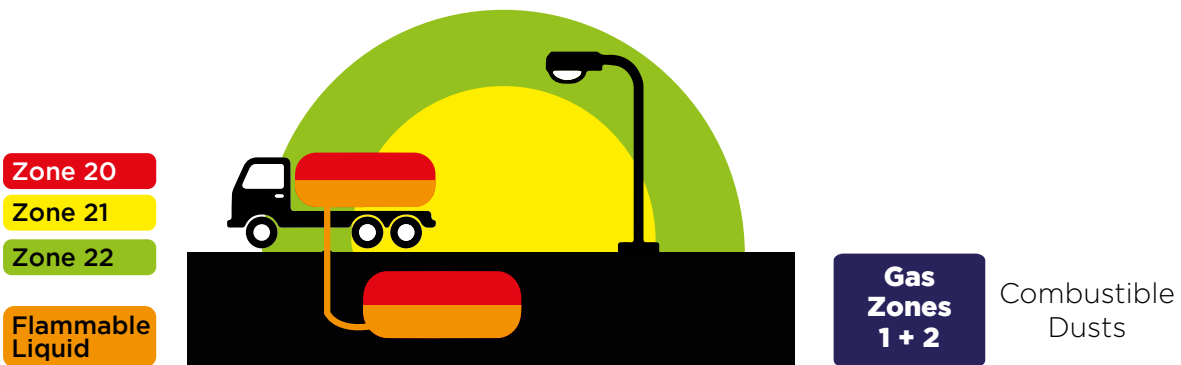

## ATEX Marking

CE mark denotes manufacturers' declaration of product compliance to all relevant EU Directives	Specific mark for Explosion Protection	Equipment Group (Mining)	Equipment Category (Mining)	Not For Use In Mines	Atex Category 1 (Old Zone 0)	Tested for Gases, Vapour and Dust Atmospheres

## ATEX EX MARKING FOR EXPLOSIVE DUST ATMOSPHERES

Explosion Protected Equipment	Intrinsic safe 'i'	Dust Group	Temperature Classification	Equipment Protection Level	Ingress Protection Level Marking

## ATEX EX MARKING FOR EXPLOSIVE GAS ATMOSPHERES

Explosion Protected Equipment	Intrinsic Safe 'i'	Gas Group	Equipment Protection Level	Gas Group	Temperature Classification	Equipment Protection Level

# EX-1400R

## ATEX Rechargeable Portable Floodlight, 1265 Lumens

The EX1400R is a portable, intrinsically safe rechargeable LED floodlight for use in zones 1, 2, 21 & 22 hazardous areas. This explosion proof floodlight is both compact and easy to use, offering an impressive 10 hours run time. This floodlight comes complete with magnetic feet or stainless steel stand.



**GAS ZONES**  
1 + 2

**DUST ZONES**  
21 + 22

### KEY FEATURES:

- 1400 Lumens, Cool White
- 10 metre beam
- Run up to 12 hours
- Rechargeable lithium battery - 6600mAh
- Intrinsically safe LED floodlights for use in hazardous areas
- Explosion proof
- High powered SEOUL LED, 10W
- Mount on stand or magnetic feet
- High strength aluminium housing
- Compact, ideal for confined spaces



**1400 LUMENS**



**10 METRES**



**12hrs**



**Choice of Bases**  
**Magnetic Feet or Stainless Steel Stand**

PRODUCT CODE: NSEX1400R (With Stand)  
NSEX1400R-MAG (Magnetic Feet)

**3 YEAR WARRANTY\***



### CERTIFICATION:

- ATEX ZONE 1, 21
- ATEX ZONE 2 & 22
- Rohs
- IECEX
- IK 08
- ABS
- IP66
- CE
- Ex db op is II C T\* Gb
- Ex tb op is IIIC T\* Db



**RoHS**



# Atex Linear Lights

6 Models Available: 24W, 36W, 50W, 60W, 72W and 80W

The EXLINEAR range is a explosion proof light fittings suitable for surface mounted in zones 1, 2, 21 & 22 hazardous areas and is an ideal replacement for fluorescent light fittings.



2,712 lumens 24W



4,212 lumens 36W  
6,250 lumens 50W  
7,380 lumens 60W  
8,424 lumens 72W  
9,120 lumens 80W

**GAS ZONES**  
1 + 2

**DUST ZONES**  
2 + 22



## KEY FEATURES:

- AC 100-277V ~ 50/60Hz
- Low-profile, lightweight design
- High aluminium housing
- Impact resistant diffused lens
- Stainless steel bracket for ceiling mount
- Professional light distribution, uniformed illumination
- Single-ended feed-through cable or double ended optional
- Temperature class: T1 to T6
- Standard 6-12KV surge protection
- Enclosures attached to back brackets



### 24W



**2,712 LUMENS**

**DIMENSIONS**  
385x126  
x88mm



PRODUCT CODE: NSEXLINEAR2712

### 36W



**4,212 LUMENS**

**DIMENSIONS**  
685x126  
x88mm



PRODUCT CODE: NSEXLINEAR4212

### 50W



**6,250 LUMENS**

**DIMENSIONS**  
1281x126  
x88mm



PRODUCT CODE: NSEXLINEAR6250

### 60W



**7,380 LUMENS**

**DIMENSIONS**  
1281x126  
x88mm

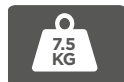

PRODUCT CODE: NSEXLINEAR7380

### 72W



**8,424 LUMENS**

**DIMENSIONS**  
1281x126  
x88mm



PRODUCT CODE: NSEXLINEAR8424

### 80W



**9,120 LUMENS**

**DIMENSIONS**  
1281x126  
x88mm



PRODUCT CODE: NSEXLINEAR9120

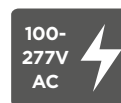

**RoHS**

## CERTIFICATION:

- ATEX Zone 1 & 21 and 2 & 22
- Ex II 2 G Ex emb IIC T6 Gb
- EX II 2 D Ex tb IIIC 80°C Db IP66



## LED Floodlight, 17000 Lumens

The EX-17000 is a intrinsically safe LED floodlight for use in Zone 2 & Zone 22 hazardous areas



0-360° Adjustable Brackets Included



**GAS ZONES 2**

**DUST ZONES 22**

### KEY FEATURES:

- 17,000 Lumens
- 43 metre beam
- AC 110/120 or 220/240V - 50/60Hz
- Intrinsically safe LED floodlight for use in hazardous areas
- High strength Aluminium housing
- Long range Floodlight
- Ultra bright high power OSRAM LED light output, 120W

	<b>HIGH</b> <b>17,000 LUMENS</b>
	<b>43 METRES</b>
	<b>110-240V AC</b>
	<b>IP66 RATING</b>
	<b>DIMENSIONS</b> 425.5mm x 336mm
	<b>10.4 KG</b>

PRODUCT CODE: NSEXFLOOD17000

### CERTIFICATION:

- Ex nR IIC T5 or T6 Gc
- Ex tb IIIC T95°C or T85°C Dc IP66
- ATEX ZONE 2 & 22
- ATEX Certificate No.: TÜV 15 ATEX 7672 X
- Rohs
- ABS
- IK 08
- CE
- IP66



**RoHS**



# SOLAREX-4800

## Rechargeable Portable LED Floodlight, 4800 lumens

The SOLAREX is a robust portable intrinsically safe LED floodlight, producing a very powerful 4800 lumens. This explosion proof portable floodlight has an adjustable 40° degree head, offering an impressive 33 hours run time.

Coming Soon



### KEY FEATURES:

- 4,800 Lumen
- 50 metre beam
- Runs up to 33 hours
- Rechargeable lithium battery (6 x 6.8A, total 40.2Ah)
- Intrinsically safe LED floodlight for use in hazardous areas
- Long range Floodlight
- Adjustable 40° degree head
- Stabilising protective bars
- Robust stainless steel housing
- Textured handle for comfortable anti-slip grip
- Supplied with: AC charger

	HIGH	MEDIUM	LOW	
LIGHT OUTPUT	4800 LUMENS	3300 LUMENS	1800 LUMENS	
Beam	50 METRES	20 METRES	10 METRES	
	11hrs	16hrs 30MIN	33hrs	
RECHARGEABLE LITHIUM BATTERY	IP65 RATING	CHARGING TIME 8HRS	DIMENSIONS 393x325 42.7mm	11 KG

PRODUCT CODE: NSSOLAREX

3 YEAR WARRANTY\*



Battery Charging and Status Indicator

Optional accessories:



12/24V Vehicle Charger: CHIC3\_7-LI-ION

# EX-160R

## ATEX Rechargeable Flashlight, 157 lumens

The EX-160R is an intrinsically safe, explosion proof rechargeable flashlight. It is made from high strength aluminium housing with a secure grip and offers a front torch light, along with a rear flood light.



**GAS ZONES**  
1 + 2

**DUST ZONES**  
2 & 22

### KEY FEATURES:

- 157 Lumens
- 200 metre beam
- Runtime 18.5 hours
- Rechargeable lithium battery - 2.2Ah
- High powered OSRAM LED
- High strength aluminium housing
- Durable impact resistant, drop proof up to 1m
- Gas pressure release valve
- Supplied with wrist strap



### Front End Spot Light



### Rear End Flood Light



	SPOT	FLOOD
LIGHT OUTPUT	157 LUMENS	129 LUMENS
Beam	200 METRES	100 METRES
	9hrs	18hrs 30 MINS
RECHARGEABLE LITHIUM BATTERY	IP68 RATING	CHARGING TIME 6HRS
	DIMENSIONS 156mm x35mm Diameter	190g

PRODUCT CODE: NSEX160R

### CERTIFICATION:

- ATEX Zone 1 & 21 and 2 & 22
- Class I DIV 1 & 2 Groups A B C D
- Class II DIV 1 Groups E F G
- Class II DIV 2 Groups F G
- Class III DIV 1
- Class III DIV 2
- Ex ib IIC T4 Gb
- Ex tb IIIC T130°C Db IP68



RoHS



# EX-ZOOM160

## ATEX Spot to Flood Flashlight, 160 Lumens

The EX-ZOOM is a zoom spot - flood flashlight, producing 160 lumens.



**MINING APPROVED**

**GAS ZONES 0+1+2**

### KEY FEATURES:

- 160 Lumens
- 116 metre beam
- Runs up to 13 hours
- High powered LED - CREE XP-G2
- Beam Lock
- Adjustable sliding switch between light modes
- Twist head for Spot to Flood beam
- Waterproof up to 1m (IP67)
- Aluminium heat sink enhancing LED efficiency
- Durable impact resistant, drop proof up to 1m
- Gas pressure release valve
- Supplied with wrist strap

**3 YEAR WARRANTY**

Flood beam



Spot beam



	SPOT HIGH	SPOT LOW	FLOOD HIGH	FLOOD LOW
<b>LIGHT OUTPUT</b>	160 LUMENS	60 LUMENS	160 LUMENS	60 LUMENS
<b>Beam</b>	116 METRES	72 METRES	26 METRES	16 METRES
<b>Runtime</b>	6hrs	13hrs	6hrs	13hrs
<b>4XAA</b>	<b>IP67 RATING</b>	<b>DIMENSIONS</b> 184mm x52mm Diameter	<b>250g</b>	

PRODUCT CODE: NSEXZOOM

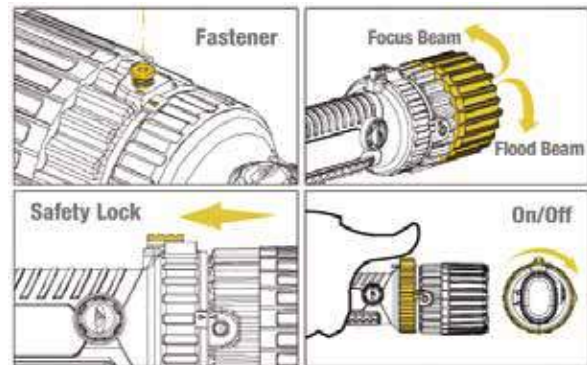

### CERTIFICATION:

- CLASS I DIV 1&2 GRP ABCD
- CLASS II DIV 1&2 GRP EFG
- CLASS III TEMP CODE: T4 IP67
- ATEX: I M1 Ex ia I Ma
- Ex II 1G Ex ia IIC T4 Ga
- DEMKO 15 ATEX 1476X
- Ex ia I Ma
- Ex ia IIC T4 Ga
- IECEx UL 15.0046X



**RoHS**





# EX-PL67

## ATEX Penlight, 67 Lumens

The EX-PL67 is an intrinsically safe penlight, it features a clip on the side. Making it easy to clip onto pockets, bags and belts.



### CERTIFICATION:

- CLASS I DIV 1&2 GRP ABCD
- CLASS II DIV 1&2 GRP EFG
- CLASS III
- TEMP CODE: T5 IP67
- FILE NUMBER E324236
- ATEX: I M1 Ex ia I Ma
- Ex II 1G Ex ia IIC T5 Ga
- DEMKO 16 ATEX 1661X
- Ex ia I Ma
- Ex ia IIC T5 Ga
- IECEx UL 16.0015X



RoHS



### KEY FEATURES:

- 67 Lumens
- 41 metre beam
- Runs up to 20.5 hours
- High powered LED - CREE XP-G2
- Lightweight pocket sized
- Pocket clip
- On/off tail switch
- Durable impact resistant, drop proof up to 1m
- Gas pressure release valve
- Supplied with wrist strap

LIGHT OUTPUT	67 LUMENS		
Beam	41 METRES		
	20hrs 30 MINS		
2XAAA	IP67 RATING		DIMENSIONS 142X30 X26mm

PRODUCT CODE: NSEXPL

# EX-150

## ATEX Flashlight, 150 lumens

The EX-150 is an 3-C cell high capacity flashlight, giving a runtime of over 80 hours. It features a has a very handy removable clip allowing you to easily attach to overalls, jackets and clip boards.



RoHS



### CERTIFICATION:

- Class I DIV 1 Groups A B C D
- Class II DIV 1 Groups E F G
- Class III
- ATEX: Ex: II 1 G
- Ex ia IIC T4
- DEMKO 13 ATEX 1112940X
- IECEx: Ex ia IIC T4 Ga

### KEY FEATURES:

- Powerful 150 Lumens
- 248 metre beam
- Runs up to 80 hours
- High powered LED - CREE XP-E
- Removable clip
- On/off tail switch
- Aluminium heat sink enhancing LED efficiency
- Durable impact resistant, drop proof up to 1m
- Gas pressure release valve

	HIGH	LOW	
LIGHT OUTPUT	150 LUMENS	57 LUMENS	
Beam	248 METRES	154 METRES	
	80hrs	42hrs 30 MINS	
3XC CELL	IP67 RATING WATERPROOF	DIMENSIONS 225X60 X80mm	190 g

PRODUCT CODE: NSEX150

# EX-325

## Atex Right Angle Hand Torch, 325 Lumens

The EX-325 is a right angled hand torch. The rugged torch has a robust polycarbonate housing and a rubberised head and grip for external durability. It features a has a very handy rear pocket clip allowing you to easily attach to overalls, jackets or belts.



**UPGRADED  
VERSION  
325  
LUMENS**



**3  
YEAR  
WARRANTY**

**GAS  
ZONES  
0+1+2**

**MINING  
APPROVED**

### KEY FEATURES:

- 325 Lumens
- 290 metre beam
- Runs up to 13 hours
- High powered LED - CREE XP-G2
- Lockable battery compartment
- Robust Polycarbonate Housing
- Rubber grip and head for durability
- Pocket/Belt stainless steel clip
- Durable impact resistant, drop proof up to 1m
- Easy to use, maintenance free
- Gas pressure release valve

	HIGH	LOW
LIGHT OUTPUT	<b>325 LUMENS</b>	<b>140 LUMENS</b>
Beam	<b>290 METRES</b>	<b>184 METRES</b>
	<b>6hrs 30 MINS</b>	<b>13hrs</b>
4XAA	<b>IP54 RATING</b>	<b>DIMENSIONS 183mm x69mm x63mm</b>
		<b>250g</b>

PRODUCT CODE: NSEX325

### CERTIFICATION:

- CLASS I DIV 1&2 GRP ABCD  
CLASS II DIV 1&2 GRP EFG  
CLASS III  
TEMP CODE: T4 IP54  
FILE NUMBER:261379

- ATEX: Ex I M1 Ex ia I Ma  
Ex II 1G Ex ia IIC T4 Ga  
Sira 15ATEX2166X

- IECEx: GAS:Ex ia IIC T4 Ga  
MINING:Ex ia Ma  
IECEx SIR 15.0062X



**RoHS**



Photo taken by faethon71

# EX-185

## ATEX Flashlight, 185 Lumens

The EX-185 is an lightweight flashlight, it features a safety lock to prevent being accidentally switched on. Ideal for use in the fire & emergency services and utility companies.



**UPGRADED  
VERSION  
185  
LUMENS**

**3  
YEAR  
WARRANTY\***

### KEY FEATURES:

- 185 Lumens
- 117 metre beam
- Runs up to 30 hours
- High powered LED - CREE XP-G2
- Safety locks to prevent accidentally turning on
- Aluminium heat sink enhancing Led efficiency
- On/off tail switch
- Waterproof up to 3metres (IP68)
- Durable impact resistant, drop proof up to 1m
- Easy to use, maintenance free
- Gas pressure release valve
- Ideal for Oil and Gas Industry, Mining Industry, Utility Companies
- Supplied with wrist strap

PRODUCT CODE: NSEX185

### CERTIFICATION:

- ATEX: Ex II 1 G | Ex ia IIC T4 IP68  
DEMKO 13 ATEX 1205039X
- Class I DIV 1 Groups A B C D
- Class II DIV 1 Groups E F G
- Class III DIV
- IECEx: Ex ia IIC T4 GA IECEx  
UL 13.0060X



**RoHS**



**GAS  
ZONES  
0 + 1 + 2**

	HIGH	LOW	FLASHING
LIGHT OUTPUT	<b>185 LUMENS</b>	<b>70 LUMENS</b>	<b>180 LUMENS</b>
Beam	<b>117 METRES</b>	<b>83 METRES</b>	<b>117 METRES</b>
	<b>8hrs</b>	<b>30hrs</b>	
4XAA	<b>IP68 RATING</b>	<b>DIMENSIONS 172mm x47mm Diameter</b>	<b>140g</b>





**Optional Helmet Clips -  
Compatible for all the following Atex flashlights:  
EX-185  
Contact our sales team to find out more**



# EX-HT80

## Compact ATEX Head Torch, 80 Lumens

The EX-HT80 is a compact ATEX head torch. Easy twist on and off bezel switch.



**3** YEAR WARRANTY\*

**MINING APPROVED**

**GAS ZONES 0+1+2**

### KEY FEATURES:

- 80 Lumens
- 70 metre beam
- Runs up to 14 hours
- Intrinsically safe LED head torch for use in hazardous areas
- High powered LED - CREE XP-G2
- Adjustable headband to fit users head or helmet
- Aluminium heat sink enhancing LED efficiency
- Durable impact resistant, drop proof up to 1m
- Easily twist on/off bezel switch while wearing fire gloves
- Powered by 3x AAA batteries (not included)

### CERTIFICATION:

- Class I DIV 1 Groups A B C D
- Class II DIV 1 Groups E F G
- Class III DIV
- ATEX: M1 Ex: Ia | Ma
- II 1 G Ex ia IIC T4 GA
- DEMKO 15 ATEX 1546X
- IECEx: GAS: Ex ia IIC T4 GA
- MINE: Ex: Ia | Ma
- IECEx UL 15.0086X



LIGHT OUTPUT	<b>80 LUMENS</b>
Beam	<b>70 METRES</b>
	<b>14hrs</b>
3XAAA	<b>IP67 RATING</b>
DIMENSIONS 70X60 X53mm	<b>110 g</b>

PRODUCT CODE: NSEXHT80

# EX-HT220

## ATEX Head Torch, 220 Lumens



**3** YEAR WARRANTY\*

**GAS ZONES 0+1+2**

### KEY FEATURES:

- 220 Lumens
- 100 metre beam
- Run up to 12 hours
- High powered LED - CREE XP-G2
- Soft touch rubber switch
- 90° Adjustable angle
- Adjustable headband to fit users head or helmet
- Easily rotates while wearing fire gloves

### CERTIFICATION:

- Class I DIV 1 Groups A B C D
- Class II DIV 1 Groups E F G
- Class III DIV
- ATEX: II 1 G Ex ia IIC T4 GA IP67
- DEMKO 14 ATEX 1354X
- IECEx: Ex ia IIC T4 Ga IP67
- IECEx UL 14.0059x



	HIGH	LOW
LIGHT OUTPUT	<b>220 LUMENS</b>	<b>100 LUMENS</b>
Beam	<b>100 METRES</b>	<b>75 METRES</b>
	<b>5hrs</b>	<b>12hrs</b>
3XAAA	<b>IP67 RATING</b>	DIMENSIONS 80X50 45mm
<b>143 g</b>		

**UPGRADED VERSION 220 LUMENS**

PRODUCT CODE: NSEXHT220

 NightSearcher **LED Solar Lights**



# Solar Sentry-400

## 400 Lumens Solar Powered LED Security Light

The Solar Sentry-400 solar power security light is perfect for adding additional security around the home as well as office buildings and warehouses, and providing lighting to pathways, gardens and driveways. Absolutely no running costs! Designed to be easy to install, and no wiring is required.



Recharges from the Sun,  
no need for AC mains

### KEY FEATURES:

- Solar Powered
- Powerful 400 Lumens
- Runs up to 50 hours
- 8 Metre flood Light beam
- Rechargeable lithium battery (3.7V 2200mAh)
- Easy installation - No wiring
- Day & night auto sensors
- 8 Metre PIR detection range -  
Lights up for 30 seconds when activated
- Efficient solar panel -  
Fully Recharges in 6-8 hours
- Robust housing
- No running costs - 100% Energy savings
- Perfect for around the home, giving lighting to driveways and adding security.

LIGHT OUTPUT	<b>400 LUMENS</b>		
UP TO <b>50hrs</b>	CHARGING TIME <b>6-8hrs</b>		
RECHARGEABLE <b>LITHIUM</b> BATTERY	<b>IP65 RATING</b>	DIMENSIONS 115mm x103mm x42mm	<b>180g</b>

NSSOLARSENTRY400  
CAT/PAD: 0111/114275

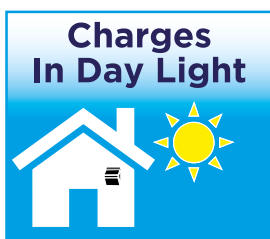

	<b>3 YEAR WARRANTY*</b>
--	-------------------------

### Choose a Light Mode

<b>1 MOTION ACTIVATION</b> High Light When Movement Is Detected	<b>2 LOW LIGHT ON AT NIGHT</b> High Light When Movement Is Detected	<b>3 LIGHT ALWAYS ON AT NIGHT</b>

	<b>Environmentally Friendly = 100% Energy Saving</b>
--	--

# Solar Sentry-1000

## 1000 Lumens Solar Powered LED Security Light

The Solar Sentry-1000 solar power security light is perfect for adding additional security around the home sheds and garages, providing lighting to driveways. It recharges from the Sun, and no AC required, takes just minutes to install. The light is supplied with a 2.5m cable for connecting the solar panel to the light.



**Charges from Sun,  
no need for AC mains**

### PIR Adjustable Motion Sensor Controls:

**TIME**



**Lighting Time:  
3 Sec. -  
7 Minutes**

**LUX**



**Night -  
Day Light  
Sensor**

**SENS**



**Distance  
Sensitivity  
0 - 12 Metre**



**Day + Night  
Auto Sensor**



**Environmentally Friendly  
= 100% Energy Saving**

### KEY FEATURES:

- Solar Powered
- Powerful 1000 Lumens
- Runs up to 10 hours
- Rechargeable lithium battery (7.4V 18000mAh)
- Easy installation - No wires
- 15 Metre flood Light beam
- 12 Metre PIR detection range -  
Lights up for 3 seconds to 7 minutes when activated
- Day & night auto sensors
- Efficient solar panel - Fully Recharges in 8-10 hours
- No running costs - 100% Energy savings
- Perfect for around the home, giving lighting to driveways and adding security.
- Supplied with 2.5 metre cable



**1000  
LUMENS**

**CHARGING  
TIME  
8-10hrs**



**IP44  
RATING**

**DIMENSIONS  
170mm  
x115m  
x105mm**



**NSSOLARSENTRY1000  
CAT/PAD: 0111/110180**



**Supplied in a counter top display**



# Solar Sentry-1100RC

## 1100 Lumens Solar Powered LED Security Light

The Solar Sentry-1100RC motion sensor security light is a great addition for around the home and workplace, providing extra lighting to yards, driveways, and gardens, and adding security for peace of mind. The remote control makes it easy to control the five light modes. It features a PIR motion detector that picks up movement from up to 8 metres, and there are absolutely no running costs! Designed to be easy to install, and no wiring is required.



Remote Control  
5 Light Modes

Charges from sun,  
no need for AC mains



Day + Night  
Auto Sensor

### KEY FEATURES:

- Solar Powered
- Powerful 1100 Lumens
- Runs up to 8 hours
- Rechargeable lithium battery (3.7V 7800mAh)
- Easy installation - No wires
- 20 Metre flood beam
- 8 Metre sensor detection - Lights up for 30 seconds when activated
- Day & night auto sensors
- Battery charging indicator
- Efficient solar panel - Fully Recharges in 6-8 hours
- No running costs - 100% Energy savings
- Perfect for around the home, giving lighting to driveways and adding security.

### DAY MODE

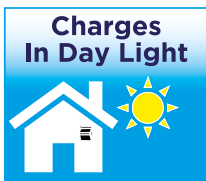

Choose a  
Night Mode

### FIVE NIGHT MODES



**1 MOTION ACTIVATION**

Low Light On,  
High Light When  
Movement  
Is Detected



**2 POWER SAVING**

No Light On,  
High Light When  
Movement  
Is Detected



**3 LIGHT ALWAYS ON AT NIGHT**

Low Light On  
All Night,  
Turn Off  
At Daytime



**4 AUTOMATIC**

Lights On When  
Charged +60%  
Switches To  
Mode 2 -60%



**5 EMERGENCY**

Switch On With  
Remote Control  
High Light  
For 1 hour Only

Environmentally Friendly = 100% Energy Saving



**1100 LUMENS**



**UP TO 8hrs**



**CHARGING TIME 6-8hrs**

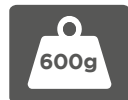
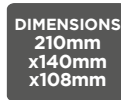

NSSOLARSENTRY1100RC  
CAT/PAD: 0111/114319





**Crushproof, Up to 3 tonnes  
- shock resistant**



**Demarcation**



**White flood light setting  
Strong magnetic back**

# Pulsar Pro Rechargeable

## Emergency Rechargeable LED Hazard Lights

The PULSAR Pro is a multi-mode, rechargeable LED warning light designed for traffic control, signalling, hazard awareness, zone demarcations and vehicle safety. Ideal for professional applications, including the Police, Fire, and Highway Services. These small but robust units are manufactured in shock resistant plastic housing, are waterproof (up to 10 metres) and virtually indestructible (withstanding most vehicle weights if crushed). Built in magnets allow attachment to vehicles or any metal surfaces.



Single Rechargeable Pulsar

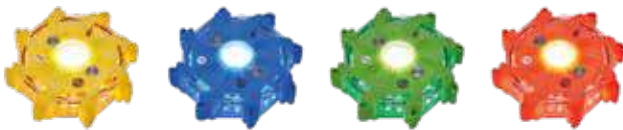

Video Link



### KEY FEATURES:

- Visible from over 1 Kilometre
- 360° Illumination
- 10 Light modes
- Waterproof up to 10m
- Floats in water
- Central white work lights
- Magnetic back
- Virtually indestructible
- Shock resistant plastic housing
- Working Temperature -40° to 60°C
- Designed for traffic control, signalling, hazard awareness, zone demarcations and vehicle safety including the Police, Fire and Highway Services.
- Supplied with: Charging base, charging cable, car charger

### Run times for light modes:

Rotate	9hrs	Quad Flash	9hrs
Single Blink	60hrs	Alternating Blinks	9hrs
SOS Rescue	14hrs	Steady on High	5hrs
Steady on Low	35hrs	2 LED Lights	28hrs
4 LED Lights	18hrs	White Torch Mode	8hrs
RECHARGEABLE LITHIUM BATTERY	IP67 RATING	CHARGING TIME 10HRS	DIMENSIONS 24mm x110mm Diameter
			200g

PRODUCT CODE:	MILLICANDELA (MDC)
NSPULSARPRO-B: Blue	6,000
NSPULSARPRO-G: Green	11,000
NSPULSARPRO-R: Red	7,000
NSPULSARPRO-Y: Yellow	7,500



Recharges via inside charging case

## Set of Five Rechargeable Pulsar Pro

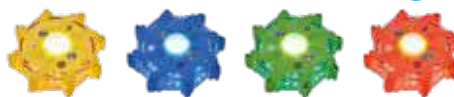

PRODUCT CODE:	MILLICANDELA (MDC)
NSPULSARPRO5-B: Blue	6,000
NSPULSARPRO5-G: Green	11,000
NSPULSARPRO5-R: Red	7,000
NSPULSARPRO5-Y: Yellow	7,500
CAT/PAD: 0111/107593	

### OPTIONAL ACCESSORIES:



Cone Mount  
SPPULSARMAG

# Sequential Rechargeable Pulsar Pro

## Set of Five Hazard Warning Lights

This sequential version of Pulsar Pro has the advantage of having a simplified sequential flash operating mode with a raised power button inside the case to activate the sequence instantly for quick deployment. This provides a 'flow' effect of light as each Pod flashes in turn, ideal for use on faster roads where a greater distance is needed between light units.



Cone Mount  
SPPULSARMAG

### Run times for light modes:

Rotate	9hrs	Quad Flash	9hrs
Single Blink	60hrs	Alternating Blinks	9hrs
SOS Rescue	14hrs	Steady on High	5hrs
Steady on Low	35hrs	2 LED Lights	28hrs
4 LED Lights	18hrs	White Torch Mode	8hrs
Sequential	15hrs		

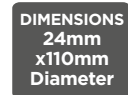

PRODUCT CODE:	MILLICANDELA (MDC)
NSPULSARPROSQ-B: Blue	6,000
NSPULSARPROSQ-G: Green	11,000
NSPULSARPROSQ-R: Red	7,000
NSPULSARPROSQ-Y: Yellow	7,500

- Ideal for road side hazards, traffic control, signalling, hazard awareness and vehicle safety. Emergency Responders, Police, Fire and Highway Services.

Supplied with: Charging base, charging cable, car charger



# Single Pulsar-AAA

## Hazard Warning Lights

The PULSAR-AAA is a multi-mode LED warning light within a shockproof housing, able to withstand crushing by weights of up to a tonne. These compact lights are designed for hazard awareness or signalling. They are extremely robust & waterproof, as well as being magnetic, so they can be attached to vehicles or other steel surfaces. Capable of operating for up to 25 hours dependant on chosen mode.



### KEY FEATURES:

- Visible from over 1 Kilometre
- 360° Illumination
- 10 Light modes
- Waterproof up to 10m
- Floats in water
- White torch setting
- Magnetic back
- Virtually indestructible
- Shock resistant plastic housing
- Working Temperature -40° to 60°C
- Designed for traffic control, signalling, hazard awareness, zone demarcations and vehicle safety including the Police, Fire and Highway Services.
- Supplied with: 3 x AAA batteries

### Run times for light modes:

Rotate	8hrs	Quad Flash	8hrs
Single Blink	25hrs	Alternating Blinks	8hrs
SOS Rescue	12hrs	Steady on High	7hrs
Steady on Low	20hrs	2 LED Lights	25hrs
4 LED Lights	18hrs	White Torch Mode	20hrs

3XAAA BATTERIES	IP67 RATING	DIMENSIONS 34mm x110mm Diameter	170g
-----------------	-------------	---------------------------------	------

PRODUCT CODE:	MILLICANDELA (MDC)
NSPULSARAAA-B: Blue	6,000
NSPULSARAAA-G: Green	11,000
NSPULSARAAA-R: Red	7,000
NSPULSARAAA-Y: Yellow	7,500



Fold away hanging hook



Video Link



Cone Mount SPPULSARMAG



Crushproof - Up to 1 tonnes

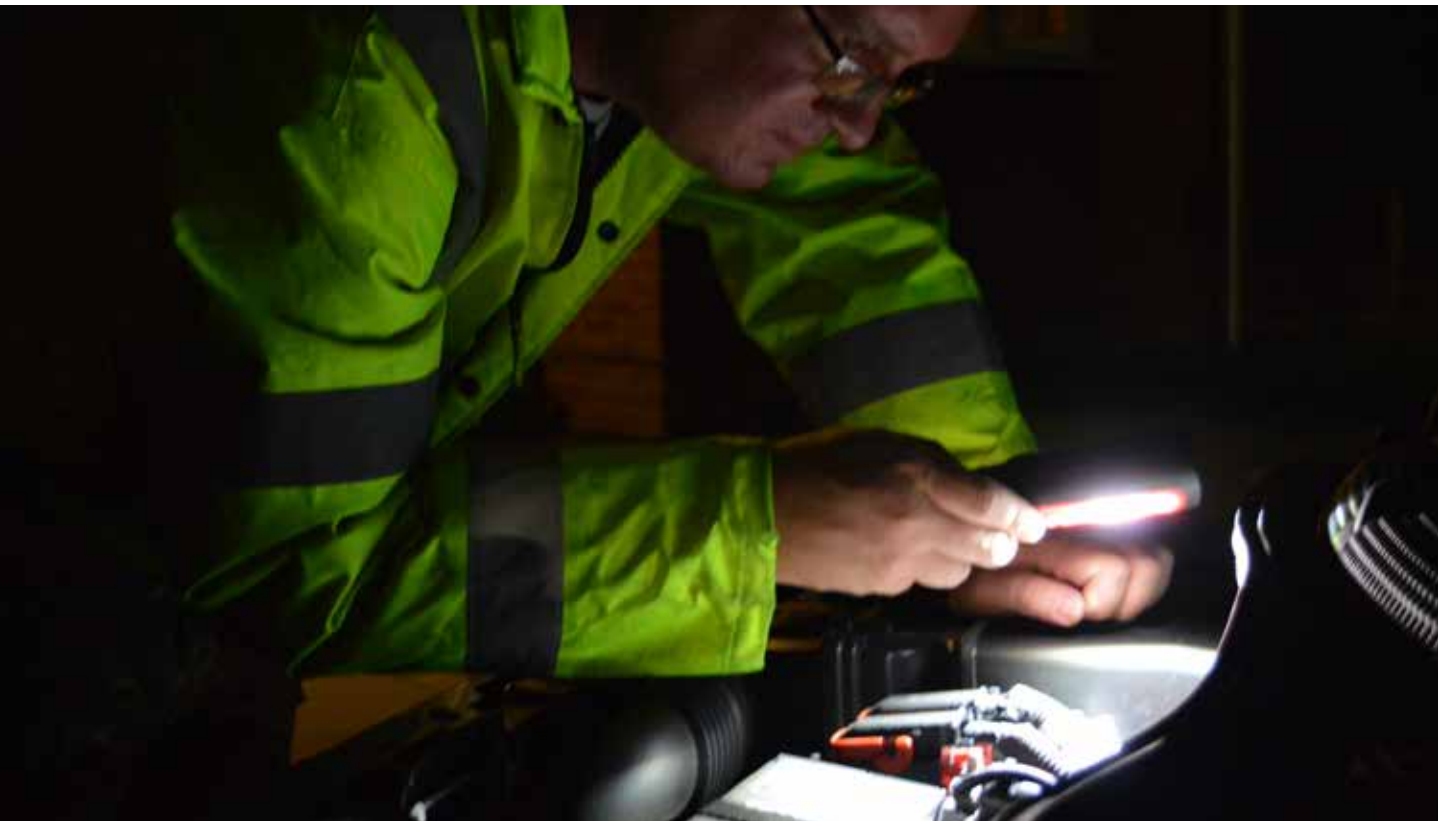

## Rechargeable Led Inspection Light

The PRO250 is a rechargeable cordless LED inspection lamp, ideal for mechanics and for inspection work. It has 2 lights a high power narrow torch beam and a wide flood beam. Supplied with a drop in charging base for easy recharge. The PRO250 can has a twist and swivel magnetic base for multi-directional lighting and hands free use.



Top Led torch beam

Wide Led flood beam

Strong Magnetic Base

### KEY FEATURES:

- 250 Lumens
- Runs up to 6 hours
- Rechargeable lithium battery (3.7V 2200mAh)
- Produces clear white light
- Wide angle of light output that has uniform intensity
- USB Rechargeable and cordless
- Magnetic back and base for hands free use
- Battery status and charging
- Integrated foldable hanging hook
- Anti-slip comfortable grip
- Charging battery status
- Resilient polycarbonate and ABS construction
- Supplied with: AC mains charger, 12V + 24V DC vehicle charger, charging base, Micro USB cable

	WIDE BEAM	NARROW BEAM	
LIGHT OUTPUT	250 LUMENS	60 LUMENS	
TIME	2.5hrs	6hrs	
RECHARGEABLE LITHIUM BATTERY	CHARGING TIME 4HRS	DIMENSIONS 196mm x80mm Diameter	320g

PRODUCT CODE: NSPRO250/-EU



Drop in charging base for easy recharge



Twist and swivel base.



# NEW i-Spector 220

## USB Rechargeable LED Inspection Light

The i-Spector220 is a unique inspection light, which separates to recharge through any USB socket. No Cable is required. It is constructed from robust ABS housing with rubber coating. Fitted with two magnets on the base and back plus handy hanging hook.

Led flood beam



### KEY FEATURES:

- 220 Lumens
- Runs up to 5 hours
- Rechargeable lithium battery (3.7V 2200mAh)
- USB battery charging port
- Strong magnetic base and back for hands free use
- 360° rotate and swivel hanging hook
- 2.2W COB Powerful LED
- Cordless heavy duty design
- Battery charging indicator
- Robust housing
- Resistant to chemicals & workshop solvents
- Supplied with: USB Charging cable

	<b>220 LUMENS</b>		
	<b>5hrs</b>		
<b>RECHARGEABLE LITHIUM BATTERY</b>	<b>CHARGING TIME 5HRS</b>	<b>DIMENSIONS 160mm x49mm x37mm</b>	<b>140g</b>

PRODUCT CODE: NSI-SPECTOR220



Light separates to recharge through any USB socket. No Cable required.

Supplied in a point of sale carton display packs, showcasing 6 x i-spector 220 inspector lights



## Ultra Slimline Rechargeable LED Inspection Light

The Star Blade is an ultra slim inspection light and the perfect tool for illuminating hard to reach areas. With an adjustable hook and magnetic base it's great for hands free use and the rechargeable 3.7V 2200mAh Lithium battery has 3 hours' runtime making the Star Blade an irreplaceable bit of kit for mechanics, plumbers, electricians and builders.

Slimline Design To Fit In  
Hard To Reach Places



180° rotational  
LED light

### KEY FEATURES:

- 300 Lumens
- Runs up to 3 hours
- Rechargeable lithium battery (3.7V 2200mAh)
- Slim blade design
- Exceptional clear white light output
- Magnetic base for hands free use
- Integrated hanging hook
- Micro USB charging
- Charging Indicator
- Resilient polycarbonate and ABS construction
- Supplied with AC mains, DC vehicle charger, Micro USB cable



PRODUCT CODE: NSSTARBLADE



# i-Spector 700

## Rechargeable LED Inspection Light

The i-Spector 700 inspection light is ideal for mechanics, tradesmen and other inspection work. This robust inspection light has a cordless heavy duty design with a toughened optical lens. The housing is also resistant to chemicals and workshop solvents, ensuring it meets the demands of everyday use. The swivel base is magnetic and rotates 180°, also features a hanging hook which swivels 360°.



### KEY FEATURES:

- 700 Lumens
- Runs up to 8 hours
- Rechargeable lithium battery (3.7V 2600mAh)
- Toughened optical lens
- Ultra bright 6W COB powerful LED
- Natural light 6500K
- Cordless heavy duty design
- Battery charging indicator
- Integrated hanging hook
- 360° rotate and swivel hanging hook
- Robust housing - resistant to chemicals & workshop solvents
- Anti slip grip
- Strong magnetic base
- Supplied AC charger

	HIGH	MEDIUM	LOW	TORCH
LIGHT OUTPUT	700 LUMENS	300 LUMENS	150 LUMENS	200 LUMENS
TIME	2hrs	4hrs	8hrs	8hrs
RECHARGEABLE LITHIUM BATTERY	IP54 RATING	CHARGING TIME 4HRS	DIMENSIONS 54mm x40mm x230mm	387g

PRODUCT CODE: NSISPECTOR700  
CAT/PAD: 0111/114453



# NEW i-Spector 1000

## Rechargeable Wide Angled Inspection Light

The i-Spector 1000 is professional powerful inspection lamp. It has a wide angled 180° illumination, that can be rotated and shines light straight to where it needed. It has a ultra strong magnetic base and hanging hook for hands free use. The inspection light features an adjustable dimming switch ideal for mechanics, tradesmen and other inspection work.



USB Power bank - charge your phone

Dimmable light switch

Magnetic base

### KEY FEATURES:

- 1000 Lumens
- Runs up to 27 hours
- Rechargeable lithium battery (3.7V 5200mAh)
- 180° Illumination
- Adjustable dimming switch
- Wide angled beam
- Battery charging and status indicator
- ABS Plastic + PC lens
- Robust aluminium housing
- Bright SMD Led lights
- USB rechargeable
- Adjustable hanging hook
- Supplied with: AC charger and USB charging cable

	HIGH	DIMMABLE		
	1000 LUMENS	60-1000 LUMENS		
	27hrs	2-27hrs		
RECHARGEABLE LITHIUM BATTERY	IP54 RATING	CHARGING TIME 3.5HRS	DIMENSIONS 260mm x75mm Diameter	489g

PRODUCT CODE: NSI-SPECTOR1000



180° rotational LED light



# NEW Micro-1000

## Rechargeable LED Work Light

The Micro-1000 is ultra compact LED work light, that fits into the palm of your hand. The light is protect by the robust housing which can be rotated 360° and has a wide 90° flood beam. Ideal for use in confined spaces under flooring, kitchen cabinets etc or anywhere that you need bright portable lighting.



### KEY FEATURES:

- 1000 Lumens
- Runs up to 2 hours
- Rechargeable lithium battery (3.7V 2600mAh)
- Compact design, fits in the palm of your hand
- 360° Multi directional lights
- Glass lens for 90° degrees
- Magnetic base
- Aluminium heat sink
- Battery status and charging indicator
- Battery overcharge + discharge protection
- Ideal light for compact areas
- Supplied with USB charging cable

	HIGH	LOW		
	1000 LUMENS	500 LUMENS		
	1hr	2hrs		
RECHARGEABLE LITHIUM BATTERY	IP65 RATING	CHARGING TIME 4HRS	DIMENSIONS 78mm x76mm x52mm	220g

PRODUCT CODE: NSMICRO1000

### OPTIONAL ACCESSORIES:



Vehicle Charger: CHIC8.4-Lithium

AC Adaptor: CH-USB-UK

EU Adaptor: CH-USB-EU



## Multi-functional LED Work Light

The Star Buddy is a cordless LED inspection lamp, it has a tough construction and comes complete with an adjustable stand and magnetic base. With an powerful floodlight and torch mode for a more inspection beam of light and a red flashing mode is available in the event of an emergency. Ideal for mechanics, camping and for inspection work.

Led torch beam



Adjustable stand and magnetic

### KEY FEATURES:

- 180 Lumens
- Runs up to 4 hours
- Floodlight beam
- Inspection torch
- Ultra bright 1.5W COB LED strip
- Emergency Red flashing emergency light
- Red flashing emergency light + white light
- Adjustable & magnetic stand
- 180° degree swivel magnetic stand
- A perfect tool for camping, workshop automobile and emergency application
- Supplied with: 3 x AAA batteries

	HIGH	LOW	TORCH	FLASHING
LIGHT OUTPUT	180 LUMENS	90 LUMENS	80 LUMENS	80 LUMENS
	2hrs	4hrs	3hrs 30MIN	3hrs 30MIN
3XAAA	DIMENSIONS 122mm x56mm x21mm		60.7g	

PRODUCT CODE: NSSTARBUDDY

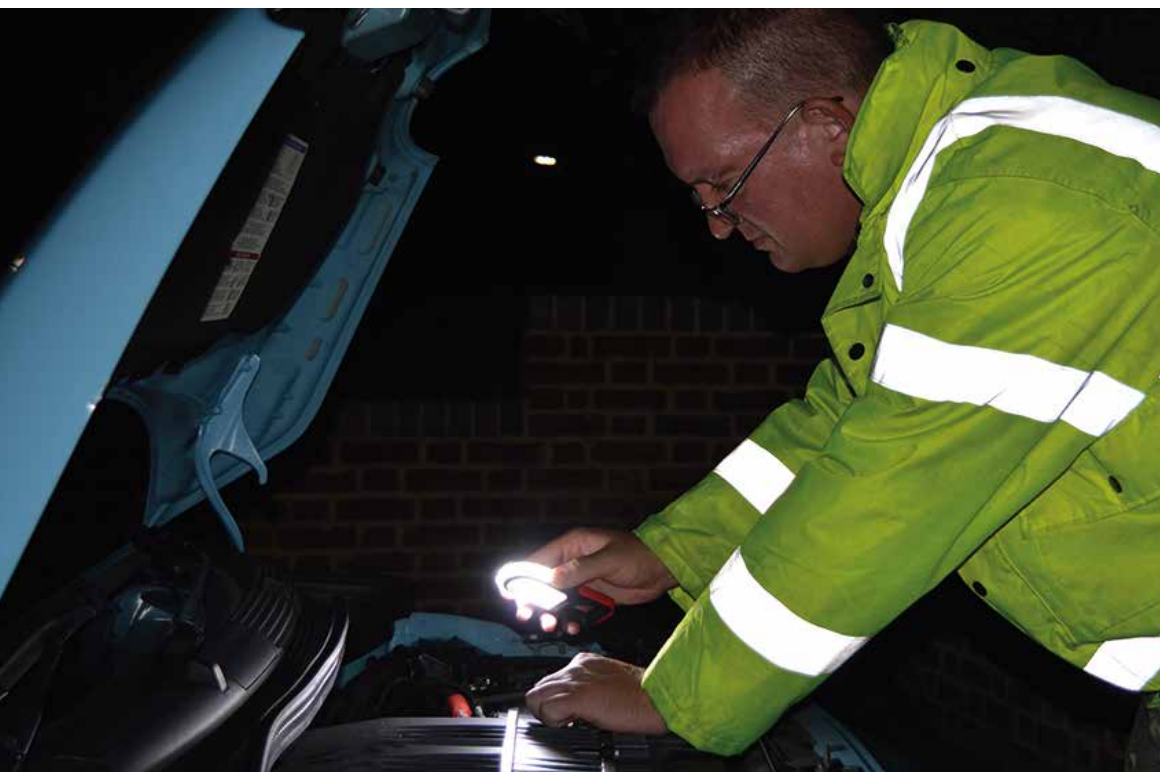

## Led Flashlight Perfect For Up Close Inspection

The PocketStar is compact, pocket sized LED light, providing a powerful 150 Lumen flood light that is ideal for inspection work and general illumination. It has a durable ABS body with soft-touch rubber coating. The magnetic pocket clip allows the light to be attached to metal surfaces for hands free use and may be swivelled through 180 degrees to shine the light in the correct position









Magnetic pocket clip



Supplied in a point of sale carton display packs, showcasing 12x pocketstar flashlights

### KEY FEATURES:

- 150 Lumens
- Runs up to 4 hours
- 180° swivel pocket clip
- Produces clear white light
- Wide angle of light output that has uniform intensity
- LED Floodlight
- Polycarbonate lens
- Rubberised ABS yellow casing
- Anti slip grip handle
- Magnetic clip for hand free use
- Compact, pocket sized
- Resilient polycarbonate and ABS construction
- Supplied with 3 x AAA batteries

HIGH	
 LIGHT OUTPUT	 150 LUMENS
 LIGHT	 4hrs
 3XAAA	 DIMENSIONS 158mm x30mm x16.9mm
	 54g

PRODUCT CODE: NSPOCKETSTAR  
CAT/PAD: 0111/120131

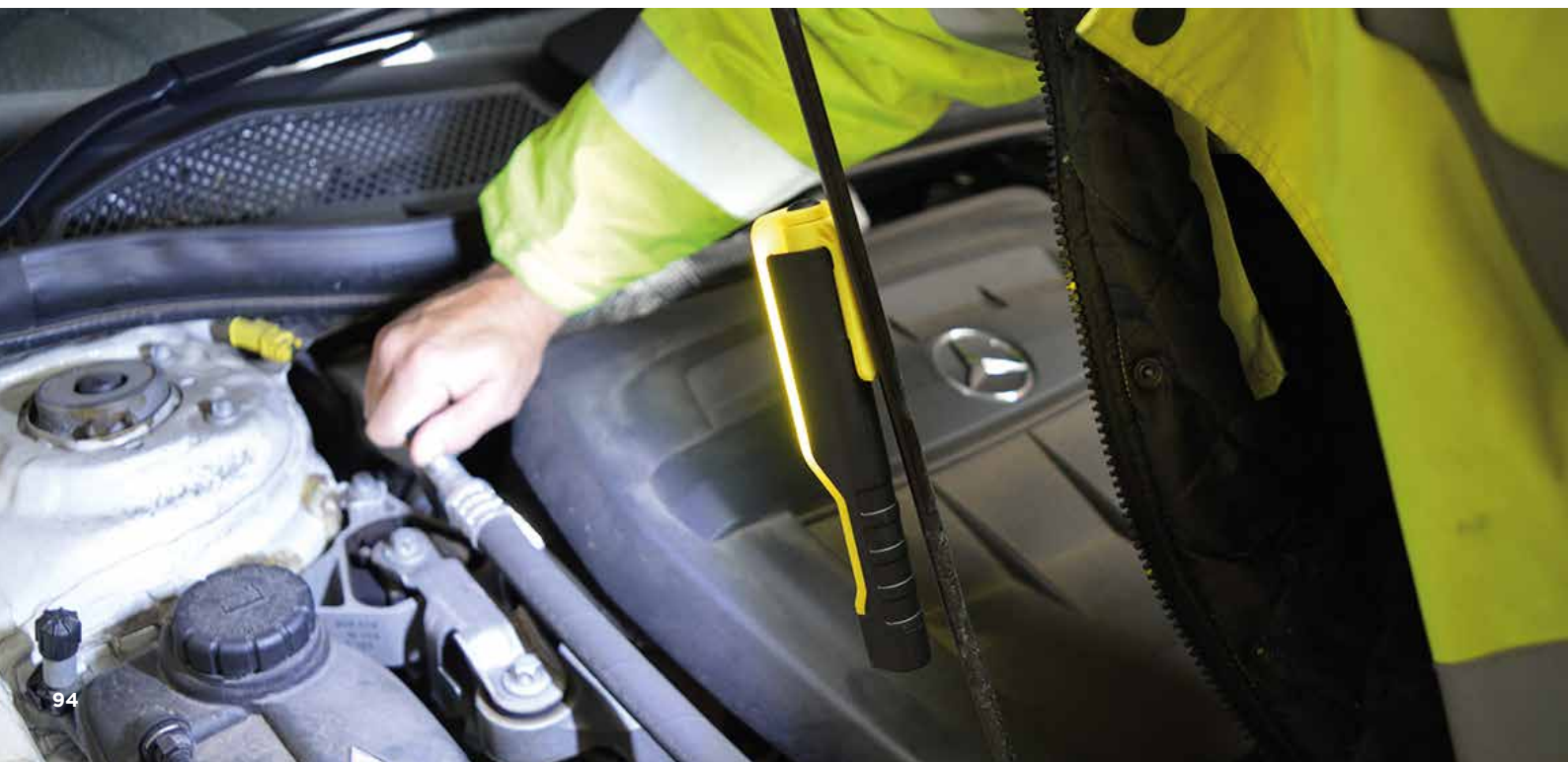

## 5 In 1 Emergency Car Kit

The LifeGuard is a car emergency kit all in one! This fantastic product is multifunctional, with a powerful floodlight and torch, a recessed razor blade cutter that frees both driver and passengers if seat belt locks, and a stainless steel emergency breaking pin that automatically deploys when pressed against side or rear window for glass breaking. The LifeGuard unit is magnetic so you can stick it to the outside of your car and use the emergency red flash warning light to get roadside assistance.



### KEY FEATURES:

- 200 Lumens
- Runs up to 5 hours
- LED flood beam
- LED inspection torch
- Window breaker
- Belt cutter
- Red flashing emergency lights
- Ultra bright 2W COB LED strip
- Red flashing emergency lights
- Strong magnetic side
- Resilient polycarbonate and ABS construction
- Supplied with 3 x AAA batteries

	FLOODLIGHT	TORCH	FLASHING
LIGHT OUTPUT	200 LUMENS	70 LUMENS	200 LUMENS
Runtime	2hrs 30MIN	3hrs	5hrs
Batteries	3XAAA		
DIMENSIONS	158mm x47.3mm		
Weight		127g	

PRODUCT CODE: NSLIFEGUARD



### 5 In 1 Emergency Car

- Floodlight
- Inspection torch
- Window breaker
- Belt cutter
- Red flashing emergency lights

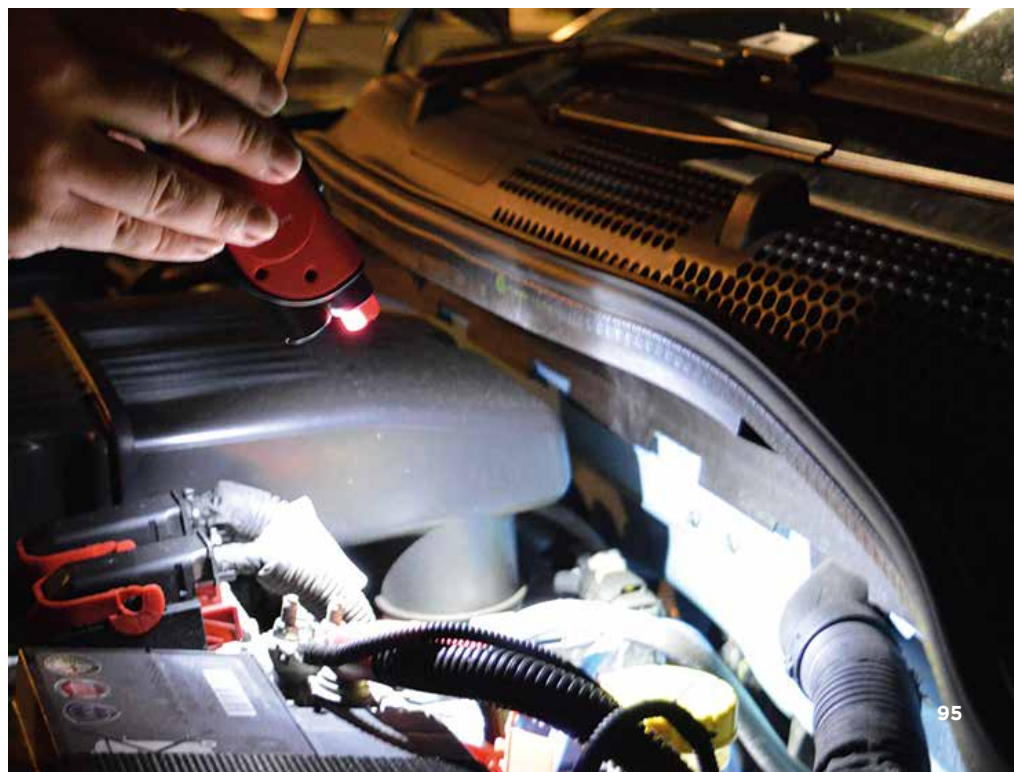

## 5 In 1 Emergency Car Kit Compact Portable Car Jump Booster, Essential Emergency Kit

The Star Booster is a multifunctional product which acts as a portable car jump starter, LED torch and floodlight with a flashing red emergency light. With its built in power bank, you can charge your mobile phone, tablet or laptop via micro USB. This compact unit is small enough to fit in your pocket or keep in the car glove box, providing an essential tool in emergencies.



### KEY FEATURES:

- Floodlight: 500 Lumens
- Torch: Runs up to 75 hours
- Rechargeable lithium battery (3.7V 2600mAh)
- Jump starter up to 3.0 litre petrol and 2.0L Diesel engine
- Red flashing emergency lights
- Reverse polarity protection
- Supplied with insulated jump cables, USB cable, AC mains charger

### FLOODLIGHT TORCH FLASHING

LIGHT OUTPUT	<b>500 LUMENS</b>	<b>300 LUMENS</b>	<b>500 LUMENS</b>
	<b>4hrs</b>	<b>7hrs 30MIN</b>	<b>75hrs</b>
RECHARGEABLE LITHIUM BATTERY	CHARGING TIME 4HRS	DIMENSIONS 166mm x96mm	447g

PRODUCT CODE: NSSTARBOOSTER  
CAT/PAD: 0111/113555

**MAX ENGINE SIZE**

- 2.0L Petrol
- 3.0L Diesel

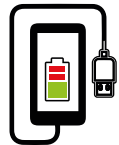

USB Power bank - charge your phone



Compact size fits in your pocket

Emergency red flashing led lights





# NEW StarBooster-X

## Jump starts to 8.0 litre petrol and 6.5L Diesel engines

The Star Booster-X will jump start up to 8.0 litre petrol and 6.5L Diesel engines and has a battery voltage reader. This handy device, has a built in LED torch and power bank, including a dual USB output offers 2.1A and 3.0A to fast charge your mobile phone, tablet or laptops. The Star Booster-X comes in a carry case and will fit in your glove box.



**JUMP STARTS UP TO 8.0L PETROL ENGINE**

**3 YEAR WARRANTY**



Battery Voltage Reader

### KEY FEATURES:

- Jump starts 12V engines up to 8.0 litre petrol and 6.5L Diesel engine
- Reverse polarity protection
- 3 light modes: High/Flashing/SOS
- High powered inspection torch
- Dual power for your mobile/tablet:
  - 1 x Quick charge 3.0A USB charging port
  - 1 x 5V 2.1A USB charging port
- Securely stored in carry case
- Heavy duty insulated jump cables
- Compact size, easily to fit in your glove box or pocket
- Supplied with insulated jump cables, Dual USB cable
- Start Current: 650 Amps, Peak Current: 1,300 Amps

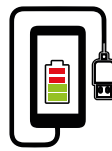

USB Power bank - charge your phone

MAX ENGINE SIZE

- 8.0L Petrol
- 6.5L Diesel

	TORCH	FLASHING	SOS
Runtime	57hrs	99hrs	115hrs
RECHARGEABLE BATTERY	CHARGING TIME 3HRS	DIMENSIONS 194mm x88mm x37.5mm	1.02g

PRODUCT CODE: NSSTARBOOSTER-X



# RiteStar CRI

## Perfect Colour Matching Range

Due to the 95CRI performance this range is the nearest you can get to natural daylight as CRI is a measure of a light sources ability to show objects and finishes “realistically or naturally compared to daylight”.

Making this range perfect for identify any blemishes, scratches or imperfections. Ideal for the Automotive industry where they are invaluable tools in the Bodyshop, Spray Booth, Polishing and Detailing departments.

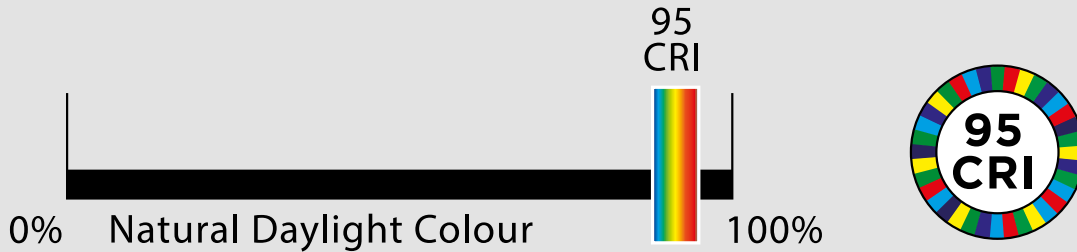

## RiteStar Pen Light

This pocket sized spot to flood pen light has a handy clip, you can easily attach to overalls or pockets! Its robust housing is also resistant to chemicals and workshop solvents, ensuring it meets the demands of everyday use. Ideal for the automotive industry, polishing and detail work applications.



### KEY FEATURES:

- 50 Lumens
- Runs up to 1.5 hours
- Perfect colour matching pen light
- Adjustable slide focus: Spot - Flood beam
- Natural daylight colour - 95 CRI
- Aluminium housing
- Powered by 2 x AAA alkaline batteries (not included)



50 LUMENS



1hrs 30MIN



2XAAA DIMENSIONS 150mm x20mm Diameter



11g



PRODUCT CODE: NSRITESTARPL

# RiteStar 400



## Rechargeable CRI LED Inspection Light

The RiteStar 400 is ideal for mechanics, tradesmen and other inspection work. This robust inspection light has a cordless heavy duty design with a toughened optical lens. The housing is also resistant to chemicals and workshop solvents. The swivel base is magnetic and rotates 180°, also features a hanging hook which swivels 360°.

### KEY FEATURES:

- 400 Lumens
- Runs up to 4 hours
- Natural daylight colour - 95 CRI
- Rechargeable lithium battery (2600mAh)
- Toughened optical lens
- Cordless heavy duty design
- Strong magnetic base and back for hands free use
- Battery status and charging indicator
- 360° rotate and swivel hanging hook
- Robust housing - resistant to chemicals & workshop solvents
- Supplied with AC charger, USB cable + charging base



	HIGH	LOW		
 LIGHT OUTPUT	400 LUMENS	200 LUMENS	 3 YEAR WARRANTY*	 95 CRI
 TIME	4hrs	2hrs		
RECHARGEABLE LITHIUM BATTERY	IP65 RATING	CHARGING TIME 4HRS	DIMENSIONS 56mm x29mm x190mm	 415g

PRODUCT CODE: NSRITESTAR400



Charging Station With Magnetic Base

## Rechargeable CRI LED Work Light

The RiteStar 700 work light is ideal for mechanics, tradesmen and other inspection work. With its robust housing and toughened optical lens ensures it meets the demands of everyday use. IP65 rating, so can be used both indoors and outdoors with an ultra strong magnetic base and carry handle also makes it highly versatile.



Adjustable stand



Battery charging and status indicator

### KEY FEATURES:

- 700 Lumens
- Runs up to 4 hours
- Natural daylight colour - 95 CRI
- Rechargeable lithium battery (2200mAh)
- Carry handle
- Toughened optical lens
- Battery charging and status indicator
- Strong magnetic base
- Robust housing - Resistant to chemicals & workshop solvents
- Optional tripod mount
- Supplied with AC + DC chargers

	HIGH	LOW		
	700 LUMENS	300 LUMENS		
	4hrs	2hrs		
RECHARGEABLE LITHIUM BATTERY	IP65 RATING	CHARGING TIME 4HRS	DIMENSIONS 170x157 x55mm	700g

PRODUCT CODE: NSRITESTAR400

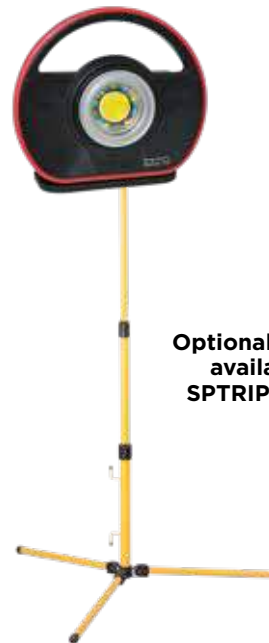

Optional tripod available  
SPTRIPOD1.7



Optional Bonnet rack  
SPRITESTARBONNET

# I-Spector UV

## Rechargeable UV 395nm LED Inspection Light

The i-Spector UV inspection light is ideal for Forensic applications and Crime investigation. This robust inspection light has a cordless heavy duty design with a toughened optical lens. Its robust housing is also resistant to chemicals and workshop solvents, ensuring it meets the demands of everyday use. The swivel base is magnetic and rotates 180°, also features a hanging hook which swivels 360°.



180° swivel base

**ULTRA VIOLET**

**3 YEAR WARRANTY\***

### KEY FEATURES:

- 365nm wavelength
- Run up to 5 hours
- Rechargeable li-ion battery (2600mAh)
- Toughened optical lens
- Cordless heavy duty design
- Strong magnetic base and back for hands free use
- Battery status and charging indicator
- 360° rotate and swivel hanging hook
- Robust housing - resistant to chemicals & workshop solvents
- Supplied with AC charger, USB cable + charging base

### Applications:



**LEAK DETECTION**



**DETECTING CRACKS**



**COUNTERFEIT MONEY**



**FORENSIC APPLICATIONS**



**COUNTERFEIT DOCUMENTS**



**Charging Station With Magnetic Base**

	<b>395 nm</b>			
	<b>5hrs</b>			
<b>RECHARGEABLE LITHIUM BATTERY</b>	<b>IP65 RATING</b>	<b>CHARGING TIME 4HRS</b>	<b>DIMENSIONS 153mm x40mm Diameter</b>	<b>415g</b>

PRODUCT CODE: NSI-SPECTORUV



**Leak Detection**

# UV395

## UV 395nm LED Flashlight

The UV395 is a compact and lightweight UV flashlight, which utilises the latest in UV technology. Featuring a powerful LED emitting an Ultra-violet beam. The UV395 flashlight is designed specifically for identifying counterfeit money, documents and passport.



**ULTRA  
VIOLET**

**3  
YEAR  
WARRANTY\***

### KEY FEATURES:

- 395nm wavelength
- Run up to 3.5 hours
- Knurled grip
- Lightweight design
- Aluminium housing - Type III hard anodised
- Tail cap tactical switch
- Water and shock resistant
- Powered by 2 x CR123A batteries (not supplied)

NightSearcher UV Flashlight are designed the following applications:



**LEAK  
DETECTION**



**DETECTING  
CRACKS**



**COUNTERFEIT  
MONEY**



**FORENSIC  
APPLICATIONS**



**COUNTERFEIT  
DOCUMENTS**

### Counterfeit Money Detection



### Passport Detection

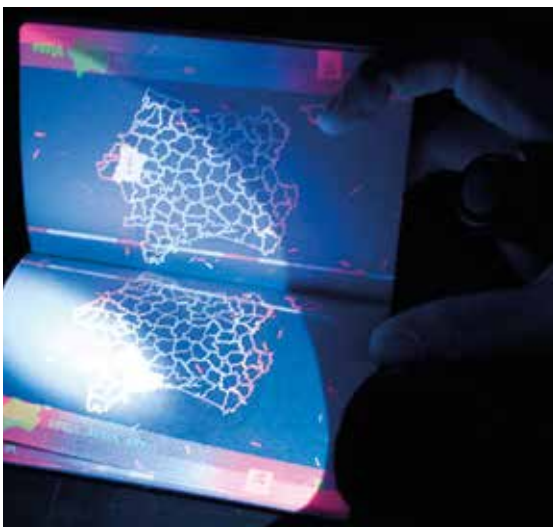

**395  
nm**



**3.5hrs**



**DIMENSIONS  
132mm  
x33.5mm  
Diameter**



PRODUCT CODE: NSUVLED395

CAT/PAD: 0111/112331

### Forensic Detection



## Rechargeable UV 365nm LED Flashlight

The UV365 is a compact and lightweight UV flashlight, which utilises the latest in UV technology. Featuring a 6W powerful LED emitting a Ultra-violet beam. The UV365 flashlight is designed specifically for Forensic applications and Crime investigation.



**ULTRA  
VIOLET**

**3  
YEAR  
WARRANTY\***



**Forensic Detection**

### KEY FEATURES:

- 365nm wavelength
- 1,030,000uW
- Run up to 3 hours
- Knurled grip
- Aluminium housing - Type III hard anodised
- Tail cap tactical switch
- Water and shock resistant
- Supplied with USB charging lead, AC adaptor, 2x O-rings, 2x Rechargeable batteries, 12V-24V charger

	<b>365 nm</b>
	<b>3hrs</b>
	<b>30 METRES</b>
<b>RECHARGEABLE LITHIUM BATTERY</b>	<b>IP65 RATING</b> 
<b>CHARGING TIME 4HRS</b> 	<b>DIMENSIONS 153mm x40mm Diameter</b>
	<b>185g</b> 

PRODUCT CODE: NSUVLED365



# DarkStar

## Head Torch With Light-Sensor Automatic Light Level Recognition

The DarkStar is a high powered 170 lumen LED head torch with a unique feature: left on standby mode this unit will automatically come on in the dark or switch off in well lit areas - it's even smart enough to adjust the light level based on the surroundings! 7 light modes are available with a long range beam or flood for close up inspections. Ideal for Jogging, Running, Hiking, Camping and Dog Walking so that you can Be Safe and Be Seen!



### KEY FEATURES:

- Powerful 170 Lumens
- Runs up to 24 hours
- Auto mode - On/Off, Dimming, Night sensor
- Light position adjustment
- Emergency light
- Light level auto adjustment
- Ideal for jogging, hiking and walking the dog
- Supplied with Head Band, 3 x AAA Batteries

	HIGH	LOW
LIGHT OUTPUT	170 LUMENS	85 LUMENS
TIME	2.5hrs	24hrs
BEAM	65 METRES	30 METRES
3x AAA BATTERIES	IPX4 RATING	DIMENSIONS 39mm x63mm x451mm
		136.5 g

PRODUCT CODE: NSDARKSTAR

**BE SAFE  
BE SEEN**

**3 YEAR  
WARRANTY\***





# Run Smart

## High Visibility LED Sports Head Torch

Run Smart is a compact, soft, lightweight head torch that can be worn either as a headband or around the neck. A perfect addition if you run, jog or take the dog for a walk at night. This award winning product will help you do so safely and efficiently by providing a directed LED light that illuminates the ground in front of you, and a red flashing LED rear light, ensuring you are seen and safe.



Light and compact design.  
Can be worn as a headband  
or around neck.

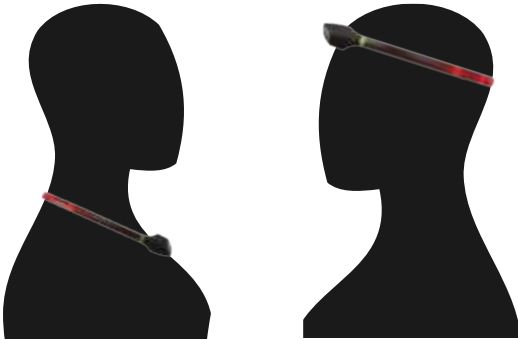

Soft, flexible silicone strap.  
Front LED light  
and rear flashing LED lights.



reddot design award  
winner 2016

### KEY FEATURES:

- Powerful 40 Lumens
- Runs up to 100 hours
- 5 Light modes: Front Light (High/Low), Rear Light (flashing), Front (High) and Rear Red light (flashing)
- Adjustable head strap
- Red rear warning lights
- Providing a directed light that illuminates the ground in front
- Ideal for jogging, running and walking the dog
- Supplied with 1 x AAA battery

	HIGH	LOW	RED FLASHING	RED FLASHING
LIGHT OUTPUT	40 LUMENS	20 LUMENS	8Hz	40Lm 8Hz
TIME	1hr 30 MINS	2hrs 30 MINS	100hrs	1hr
BEAM	6 METRES	3 METRES		
1 x AAA BATTERIES				
IPX4 RATING				
DIMENSIONS				
WEIGHT				

PRODUCT CODE: NSRUNSMART

BE SAFE  
BE SEEN

3 YEAR WARRANTY\*



## Rechargeable LED Visibility Sports Light

The EnduraStar is a rechargeable multi-purpose sports light. This clever light has simple click-on accessories which convert it to a bike light, jogging light, or emergency light



### KEY FEATURES:

- Powerful 30 Lumens
- Runs up to 5.5 hours
- Rechargeable lithium battery (3.7V 180mAh)
- 5 Light modes: Front Light (High/Low), Rear Light (Red/Red flashing, Front and Rear Red light flashing)
- Rotates for 360° illumination
- Magnetic back
- Emergency light
- Ideal for jogging, hiking and cycling
- Supplied with Bike mount, High visibility arm band and USB charging cable



Simple click arm band



Simple click on bike frame



	HIGH	LOW	
LIGHT OUTPUT	30 LUMENS	15 LUMENS	
	2hrs	5hrs 30 MINS	
Beam	18 METRES	13 METRES	
RECHARGEABLE LITHIUM BATTERY	IPX4 RATING	CHARGING TIME 1.5HRS	DIMENSIONS 51.9mm x42.2mm x21mm
			25g

PRODUCT CODE: NSENDURASTAR

**BE SAFE  
BE SEEN**

**3 YEAR  
WARRANTY\***



# Dual Star







## The Ideal Camping Partner

The Dual Star offers a high power spot beam, the torch can also be pulled up to change to lantern mode. Comes with wrist strap so can be hung inside a tent when in lantern mode. The robust aluminium body and 1 metre impact resistance means it can be used in tough conditions. The ridged handle offers a secure grip and It works as a powerbank to charge your mobile phone or tablet!



### KEY FEATURES:

- Powerful 380 Lumens
- Runs up to 10 hours
- 220 Metre beam
- Rechargeable lithium battery (3.7V 4400mAh)
- Long distance spot beam
- Pull up flood/camping lantern
- 4 modes: High, low, strobe and flashing
- Ultra bright CREE XPG LED
- Battery status and charging indicator
- Powerbank - Charge your phone
- Secure grip
- Robust aluminium housing
- Supplied with USB Charging Cable

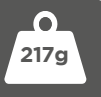
	HIGH	LOW		
 LIGHT OUTPUT	<b>380 LUMENS</b>	<b>180 LUMENS</b>	 5hrs 30 MINS	<b>10hr</b>
 Beam	<b>220 METRES</b>	<b>150 METRES</b>	 RECHARGEABLE LITHIUM BATTERY	 IP44 RATING
			 CHARGING TIME 8HRS	 DIMENSIONS 181mmx 45mm DIAMETER
				 217g

PRODUCT CODE: NSDUALSTAR

**BE SAFE  
BE SEEN**

**3**  
YEAR  
WARRANTY\*





 **NightSearcher**  
Trusted Worldwide since 1989



**UK**

Unit 4, Applied House, Fitzherbert Spur,  
Farlington, Hampshire, PO6 1TT, UK  
023 9238 9774  
[www.nightsearcher.co.uk](http://www.nightsearcher.co.uk)



**EUROPE**

Garbary 53, Poznan  
Poland  
+44 239 216 1126  
[www.nightsearcher.com](http://www.nightsearcher.com)



**HONG KONG**

Suite 2512, Langham Place Tower Office  
8 Argyle Street, Mongkok Kowloon, Hong Kong  
[nightsearcher.hk](http://nightsearcher.hk)

@nightsearcher-limited



nightsearcher-limited



@NightSearcher



@NightSearcherLtd



Nightsearcher Limited is registered in England.  
The Company Registration Number is 4661749.

**Like what you see?**

Talk to us about becoming a distributor  
[distributor@nightsearcher.co.uk](mailto:distributor@nightsearcher.co.uk)